

Neutrino430

Indoor 4x250mW

Two-Carrier

TDD eNodeB

Installation Guide

QRTB 2.9.4

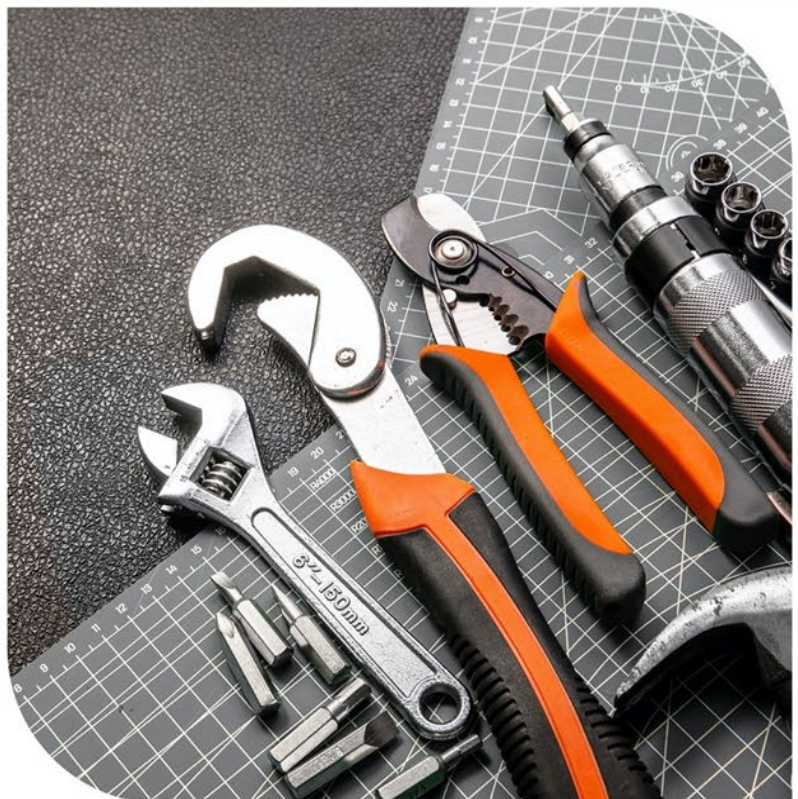

April 2022

Version 1.06

About This Document

This document is intended for personnel who will be installing the Baicells Neutrino430 Indoor 4x250mW Two-Carrier Time Division Duplexing (TDD) eNodeB (eNB) product. The product overview is followed by the procedures for properly installing, performing basic configuration, and verifying the eNB is operational. Please be advised that only personnel with the appropriate electrical skills and experience should install this device. This document is based on software version BaiBS_QRTB_2.9.4. The Neutrino430 part number is pBS31010.

Terms used in this document or related to LTE are listed in alphabetical order and described in *Acronyms and Abbreviations*, which can be found at Baicells.com > Resources > *Documents*.

Copyright Notice

Baicells Technologies, Inc., copyrights the information in this document. No part of this document may be reproduced in any form or means without the prior written consent of Baicells Technologies, Inc.

Disclaimer

The information in this document is subject to change at any time without notice. For more information, please consult with a Baicells technical engineer or the support team. Refer to the "Contact Us" section below.

Disposal of Electronic and Electrical Waste



Pursuant to the WEEE EU Directive, electronic and electrical waste must not be disposed of with unsorted waste. Please contact your local recycling authority for disposal of this product.

Revision Record

Date	Version	Description	SMEs/Contributors	Author/Editor
01-Apr-2022	1.06	Updated for editorial/non-technical changes	Jocelyn Watson	Catherine Philley
04-Mar-2022	1.05	Updated for QRTB 2.9.4	Warren Lai, Sonny May, Abel Lamas	Catherine Philley
30-Nov-2021	1.04	Updated for QRTB 2.6.2	Blake Volk, Abel Lamas	Catherine Philley
22-Jun-2021	1.03	Editorial Changes	Jocelyn Watson	Kathy Clark
21-Jan-2021	1.02	Updated for QRTB 2.5.4	Jesse Raasch, Chad Murrish, Danh PhanLe	Jocelyn Watson
18-Jan-2021	1.01	Initial release for QRTB 2.4.2	Nitisha Potti, Yang Yanan, Chad Murrish, Danh PhanLe	Jocelyn Watson

Resources

- **Documentation** - Baicells product data sheets, this document, and other technical manuals can be found at Baicells.com > Resources > [Documents](#).
- **Support** - How to open a support ticket, process an RMA, and the Support Forum are at Baicells.com > [Support](#).

Contact Us

Baicells Technologies North America, Inc. North America
5700 Tennyson Pkwy, #300, Plano, TX 75024, USA
+1-888-502-5585
sales_na@Baicells.com or support_na@Baicells.com
https://na.Baicells.com

Safety Information

For the safety of installation personnel and the protection of the equipment from damage, please read all safety warnings. If you have any questions concerning the warnings, before installing or powering on the base station, contact the [Baicells support team](#).



WARNING: IMPORTANT SAFETY INSTRUCTIONS

This warning symbol means danger. You are in a situation that could cause bodily injury. Before you work on any equipment, be aware of the hazards involved with electrical circuitry, and be familiar with standard practices for preventing accidents



WARNING: Read the installation instructions before you connect the system to its power source.



WARNING: Equipment installation must comply with local and national electrical codes.



WARNING: This product relies on the existing building or structure for short-circuit (overcurrent) protection. Ensure that the protective device is rated no greater than 20A.



WARNING: Do not operate this wireless network device near unshielded blasting caps or in an explosive environment unless the device has been modified and qualified for such use.



WARNING: To comply with the United States Federal Communications Commission (FCC) radio frequency (RF) exposure limits, antennas should be located at a minimum of 20 centimeters (7.9 inches) or more from the body of all persons.

Table of Contents

1 Overview	7
1.1 Introduction	7
1.2 Features	8
2 Installation Preparation	10
2.1 Materials	10
2.2 LEDs and Interfaces	11
2.3 Location and Environment	12
2.4 CloudCore Account	13
3 Installation	13
3.1 Process Overview	13
3.2 Install eNB on Ceiling or Wall	14
3.3 Connect Cables	16
3.3.1 PWR Power Supply, OPT Backhaul Configuration:	16
3.3.2 PWR Power Supply, WAN/PoE+ Backhaul Configuration:	17
3.3.3 WAN/PoE+ Power Supply and Backhaul Configuration:	17
3.4 Power on to Check LED Status	18
3.5 Configure Basic Parameters	18
3.5.1 Launch the eNB GUI	19
3.5.2 Upgrade Firmware	20
3.5.3 Basic Configuration Overview	21
3.5.4 Configure Network Interfaces	22
3.5.5 Configure the Management Server	26
3.5.6 Configure Quick Settings	27
3.5.7 Configure Carrier Setting	29
3.5.8 Reboot	29
3.5.9 Verify eNB Operational Status	30
Appendix: Regulatory Compliance	33
FCC Compliance	33
ISED Compliance	33

List of Figures

Figure 1-1: Neutrino430 eNB.....	7
Figure 1-2: Network Structure	7
Figure 2-1: Packout	10
Figure 2-2: LEDs and Interfaces	11
Figure 2-3: CloudCore Login Page	13
Figure 3-1: Installation Process Overview.....	13
Figure 3-2: Mark and Drill the Holes.....	14
Figure 3-3: Install Drywall Anchors and Screws	14
Figure 3-4: Fix the eNB to the Wall Bracket	15
Figure 3-5: Tighten Bolt	15
Figure 3-6: PWR Power Supply, OPT Backhaul Configuration	16
Figure 3-7: PWR Power Supply, WAN/PoE+ Backhaul Configuration	17
Figure 3-8: WAN/PoE+ and Power Supply Backhaul Configuration.....	17
Figure 3-9: Check LEDs.....	18
Figure 3-10: GUI Login	19
Figure 3-11: Home Page	20
Figure 3-12: Configuration Flow	21
Figure 3-13: WAN/LAN/VLAN	22
Figure 3-14: LGW	23
Figure 3-15 LGW = Router.....	25
Figure 3-16: Static Routing	25
Figure 3-17: Management Server	26
Figure 3-18: Quick Setting	28
Figure 3-19: Carrier Setting.....	29
Figure 3-20: Reboot	30
Figure 3-21: Cell Status (eNB GUI)	31
Figure 3-22: Cell Status (OMC).....	31
Figure 3-23: OMC > eNB > Monitor > Display Settings.....	32

List of Tables

Table 2-1: Installation Tools	11
Table 2-2: LEDs	12
Table 2-3: Interfaces	12
Table 2-4: Environmental Specifications	12
Table 3-1: WAN/LAN/VLAN.....	23
Table 3-2: LGW	24
Table 3-3: Static Routing.....	26
Table 3-4: Management Server	27

1 Overview

1.1 Introduction

The Baicells Neutrino430 (Figure 1-1) is an advanced two-carrier indoor eNodeB that is compliant with Third-Generation Partnership Project (3GPP) on Long-Term Evolution (LTE) Time Division Duplex (TDD) technology. This 4x250mW eNodeB can operate in Carrier Aggregation (CA) mode or Dual Carrier (DC)/split mode. The Neutrino430 supports broadband data access, providing various data service transformation and transmission capabilities to enable indoor wireless coverage. This eNodeB can be used by operators to improve capacity and throughput while eliminating existing dead zones.

Figure 1-1: Neutrino430 eNB



The network structure of the Neutrino430 is shown in Figure 1-2.

Figure 1-2: Network Structure

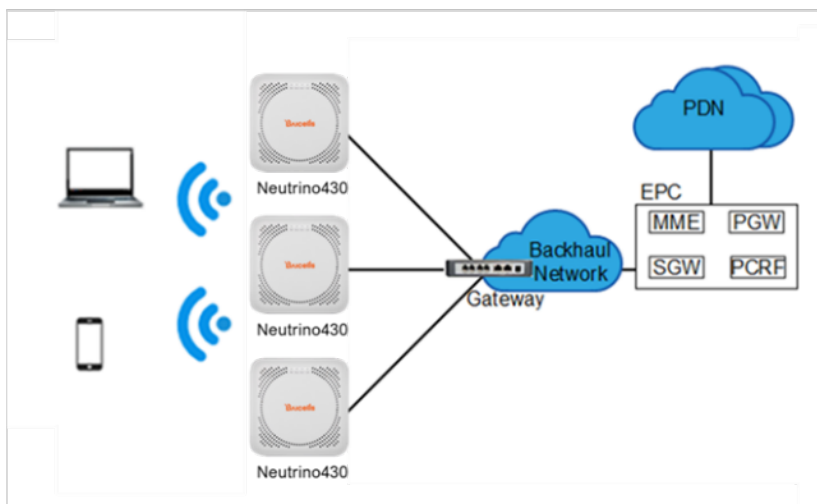

As a two-carrier eNB, the Neutrino430 hardware unit contains two separate eNBs inside one shell. Having two carriers provides versatile options in how you operate the eNB. The available operating modes are described in the next section, *Features*.

The Neutrino430's primary cell (Pcell) is referred to as Cell 1. The secondary cell (Scell) is referred to as Cell 2. Each eNB comes pre-configured to simplify the installation. Baicells provides operators with local and Web-based Graphical User Interface (GUI) software applications to configure and manage individual eNBs and Customer Premise Equipment (CPE).

Additionally, Baicells offers a centralized Software-as-a-Service (SaaS) solution called CloudCore. CloudCore includes all of the essential LTE Evolved Packet Core (EPC) network functions, an Operations Management Console (OMC) for managing multiple sites across the network, and a Business and Operation Support System (BOSS) for subscriber management.

In this document, you will find a general description, guidelines, and procedures for installing, entering basic configuration information, and verifying the operational status of the Neutrino430 eNodeB.

1.2 Features

The two-carrier Neutrino430 eNB can operate in one of several modes:

- Single Carrier (SC)
- Carrier Aggregation (CA) mode (based on software license)
- Dual Carrier (DC)/split mode (based on software license)
- HaloB mode (embedded in the base software)
- Citizens Broadband Radio System (CBRS) Spectrum Access System (SAS)

SC describes a scenario where the operator wishes to use only one of the two available cells in the eNB. This may be necessary for operators who have limited licensed spectrum or who are planning to use the second carrier later as their network grows. In SC mode, only the primary cell (Pcell), *aka* Cell 1, is used.

CA provides the ability to aggregate channels from across the full CBRS range, even channels that are not adjacent. Using CA essentially doubles the downlink capacity when all users have CAT6/7 or later customer premise equipment (CPE).

DC (split sector) mode enables the operator to run the Neutrino430 as two independent carriers for split sector coverage.

HaloB allows the eNB to function with embedded Mobility Management Entity (MME) capabilities on board so that the eNB operates independently from the usual cloud connection.

CBRS SAS is a multi-vendor Spectrum Access System database where CBRS spectrum use is managed dynamically across operators. The CBRS band covers 3.55–3.70 GHz. Operators must sign up with a SAS provider, which handles the dynamic frequency assignment and release process. Baicells provides FCC Part 96 certified eNBs, including the Neutrino430, and CPEs that operate within the Part 96 rules for CBRS. The Baicells eNBs and CPEs use a Domain Proxy (DP) to connect to the SAS server by leveraging the existing connection with the OMC.

NOTE 1: Legacy Gen 1 CPEs do not support SAS.

NOTE 2: This installation guide only covers the basic configuration of a single cell for verifying that the eNB unit is operational during the process of installation. More detailed configuration guides are available on the Baicells website:

Baicells.com > Resources > *Documents*:

- CloudCore Configuration & Network Administration Guide (OMC/BOSS)
 - CPE Configuration Guide
 - eNodeB Configuration Guide
 - Carrier Aggregation & Dual Carrier (Split Mode) Configuration Guide
 - HaloB User Guide
 - SAS Deployment Guide
-

In addition to the Neutrino430 eNB two carriers and multiple operating modes, the following is a list of other key features. The Neutrino430 datasheet providing technical specifications is kept up-to-date on the *Baicells website*.

- Supports standard LTE TDD band 48, and partial bands 42 and 43 (3550–3700 MHz)
- Complies with 3GPP Release 15 standards
- Supports 5/10/15/20 MHz bandwidth per carrier
- Provides excellent Non-Line-of-Sight (NLOS) coverage
- Peak rate is a configurable parameter using special Subframe Assignment (SA):
 - 2x20 MHz, per carrier:
 - SA1: DL 80 Mbps, UL 28 Mbps
 - SA2: DL 110 Mbps, UL 14 Mbps
 - 2x10 MHz, per carrier:
 - SA1: DL 40 Mbps, UL 14 Mbps
 - SA2: DL 55 Mbps, UL 7 Mbps
- Supports 96 concurrent users per carrier [x2 carriers (96+96) if operating in DC mode]; upgradeable to higher capacity in future software releases
- Supports TR-069 network management interface
- Can be accessed via GUI-based local and remote Web management
- Connects to any IP-based backhaul, including public transmission
- Is lightweight and uses low power consumption to reduce OPEX
- Compact, plug-and-play device with Self-Organizing Network (SON) capabilities
- Can be used for Internet of Things (IoT) with all mainstream Evolved Packet Core (EPC) vendors
- Integrated high-gain internal antenna; optional external Global Positioning System (GPS) antenna
- Integrated small cell form-factor for quick and easy installation
- Configured out-of-the-box to work with Baicells CloudCore
- Supports both Carrier Aggregation (CA) and Dual Carrier (DC) modes

- Embedded HaloB ("lite" EPC) solution
- Supports Citizens Broadband Radio Service (CBRS) with dual carrier
- GPS synchronization
- Built-in Dynamic Host Configuration Protocol (DHCP) Server, DNS Client, and Network Access Translation (NAT) functionality, providing strong high-speed routing
- Highly secured with equipment certification against potential intrusion risk

2 Installation Preparation

2.1 Materials

Check the Neutrino430 package to ensure it contains the primary components in the packout (Figure 2-1). In addition to industry-standard tools, you will need the tools described in Table 2-1.

Figure 2-1: Packout

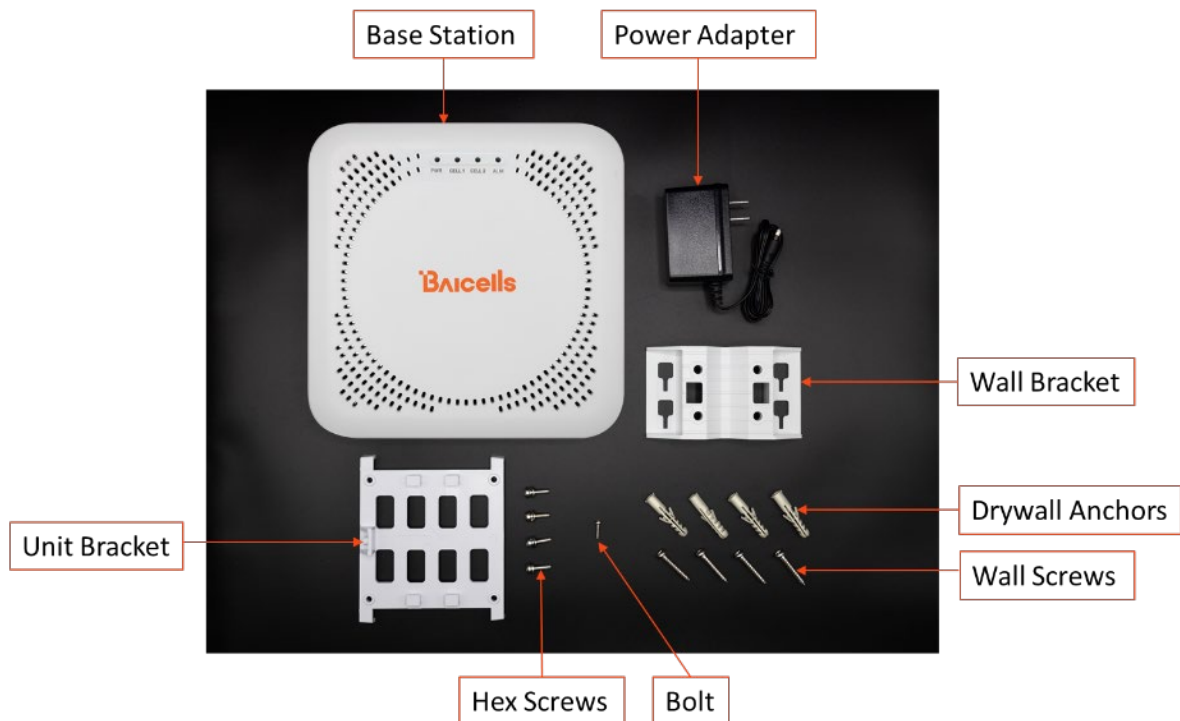







Table 2-1: Installation Tools

			
Level bar	Marker pen	Knife	Pliers
			
Wrench	Percussion drill and drill heads	Hammer	Phillips-head screwdriver
			
Cable vice (crimper)	Tape measure	0.05 cm (5 mm) L-shape Allen wrench	T7 screwdriver head

2.2 LEDs and Interfaces

Figure 2-2, Table 2-2, and Table 2-3 explain the eNB's LED status indicators and interfaces.

Figure 2-2: LEDs and Interfaces

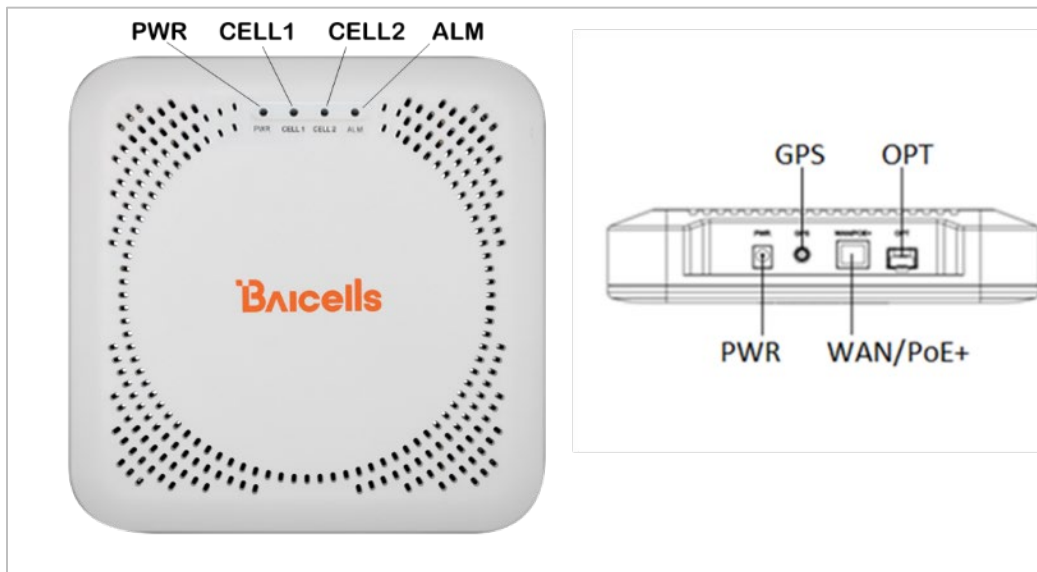

Table 2-2: LEDs

LED	Color	Status	Description
PWR	Green	Steady on	Power is on
		OFF	No power supply
CELL1	Green	Steady on	Power is on
		Fast flash: 0.125 s on, 0.125 s off	Data is transmitting
		Slow flash: 1 s on, 1 s off	The cell has been activated
CELL2	Green	Steady on	Power is on
		Fast flash: 0.125 s on, 0.125 s off	Data is transmitting
		Slow flash: 1 s on, 1 s off	The cell has been activated
ALM	Red	Steady on	Reserved
		Fast flash: 0.125 s on, 0.125 s off	S1 alarm
		Slow flash: 1 s on, 1 s off	Other alarms

Table 2-3: Interfaces

Interface Name	Description
PWR	12 VDC, 2 A power supply interface
GPS	Port for optional external GPS antenna, SMA female connector
WAN/PoE+	Gigabit Ethernet and PoE+ interface, used for debug and power supply
OPT	Optical fiber interface, connect to external transmission network, used for data backhaul

2.3 Location and Environment

The Neutrino430 can be installed on a ceiling or a wall. For the best signal coverage, place the eNB in an unobstructed location. In addition to network planning, when determining where to place the eNB, you need to consider the best location for signal coverage. Avoid locating the eNB in areas where there may be extreme temperatures, harmful gases, unstable voltages, volatile vibrations, loud noises, flames, explosives, or electromagnetic interference (e.g., large radar stations, transformer substations). Avoid areas prone to impounded water, soaking, leakage, or condensation. Environmental specifications are shown in Table 2-4.

Table 2-4: Environmental Specifications

Item	Description
Operating Temperature	23°F (-5°C) to 104°F (40°C)
Storage Temperature	14°F (-10°C) to 122°F (50°C)
Humidity	5% to 95% RH
Atmospheric Pressure	70 kPa to 106 kPa

2.4 CloudCore Account

The Baicells CloudCore includes the Evolved Packet Core (EPC), managed by Baicells, and two operator applications, Operations Management Console (OMC) to manage network elements, and Business and Operation Support System (BOSS) to manage subscribers. If you have not already set up a Baicells CloudCore account, follow the steps below.

- Step 1: Open a web browser, and enter the CloudCore address (Figure 2-3):
<https://cloudcore.cloudapp.net/cloudcore/>
- Step 2: Click on the *Sign up* button.
- Step 3: Complete the mandatory fields, and again click on *Sign up*.

Figure 2-3: CloudCore Login Page

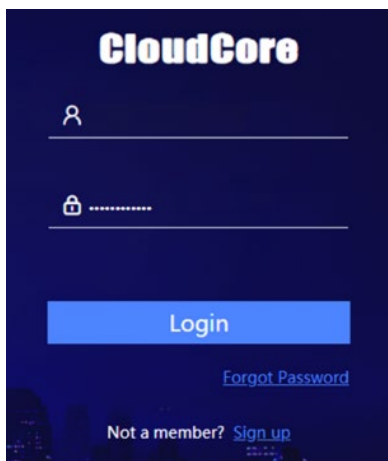

You will receive an email from Baicells. Click on the CloudCore link to go to the login page.

Enter your login user name (email address) and password to authenticate.

3 Installation

3.1 Process Overview

Figure 3-1 provides an overview of the installation process.

Figure 3-1: Installation Process Overview

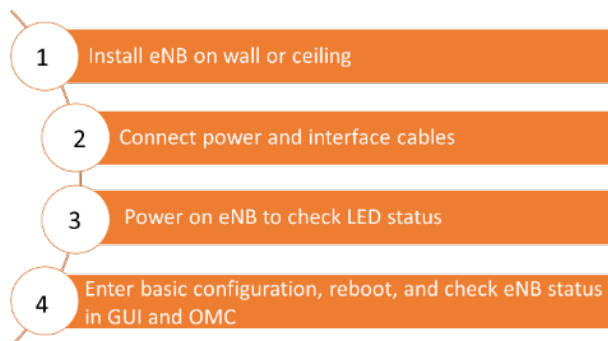

3.2 Install eNB on Ceiling or Wall

The eNB unit bracket is assembled in manufacturing before packing. The only action required by the installer is to attach the assembly to the ceiling or wall.

Follow the steps below to install the Neutrino430 eNB on the ceiling or wall.



Caution:

- Ceiling thickness must be at least 0.71 in (18 mm) and must bear a weight of at least 11.02 lb (5 kg).
 - If the ceiling is made of drywall or gypsum, it must be reinforced before installation to ensure the eNB is secure.
-

1. Fit the wall bracket on the ceiling or wall, as shown in Figure 3-2. Mark the drilling locations using a pencil or marker.
2. Drill four holes in the wall to match the size of the bracket holes.

Figure 3-2: Mark and Drill the Holes

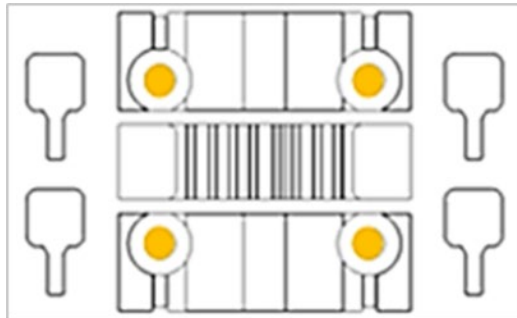

3. Install the drywall anchors and the screws, as shown in Figure 3-3.

Figure 3-3: Install Drywall Anchors and Screws

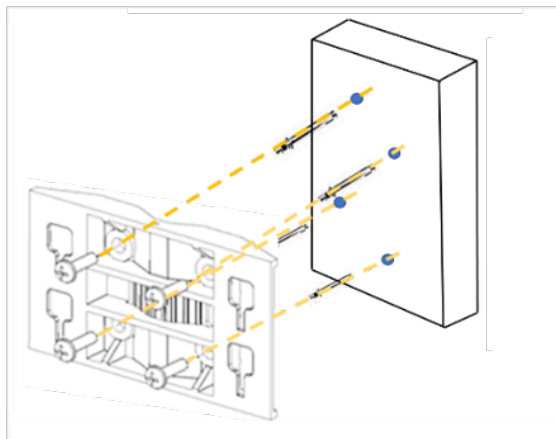

- Slide the eNB along the arrow to fix it on the wall bracket (Figure 3-4).

Figure 3-4: Fix the eNB to the Wall Bracket

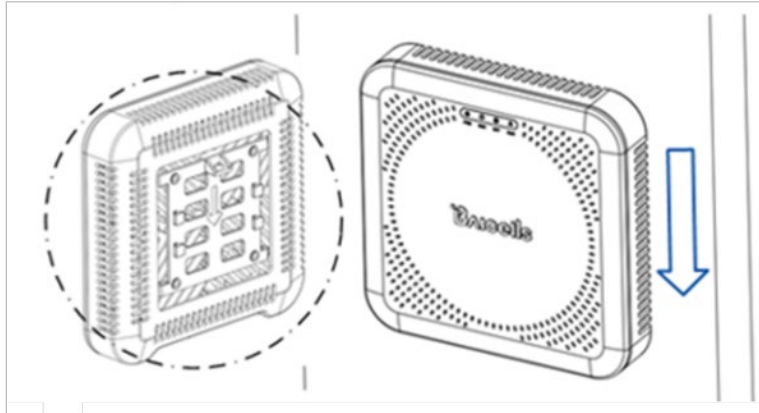

- Tighten the bolt on the top of the bracket using a Phillips-head screwdriver to complete the installation (Figure 3-5).

Figure 3-5: Tighten Bolt

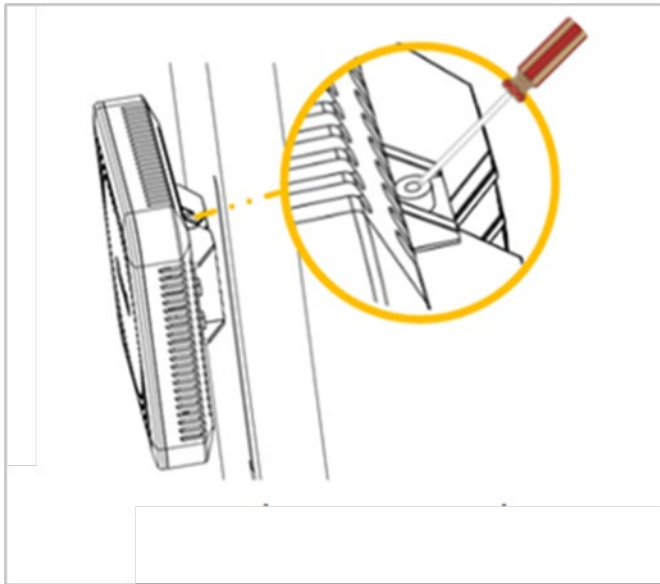

3.3 Connect Cables



WARNING: Ensure the antenna is connected before powering up the eNB. The wireless signal transmission power can cause bodily injury and damage to the eNB and RF power amplifier devices.

The power and interface cables for the Neutrino430 can be connected in three different configurations depending on your specific site requirements or setup:

- **PWR** power supply, **OPT** backhaul, [section 3.3.1](#)
- **PWR** power supply, **WAN/PoE+** backhaul, [section 3.3.2](#)
- **WAN/PoE+** power supply and backhaul, [section 3.3.3](#)

3.3.1 PWR Power Supply, OPT Backhaul Configuration:

Connect the cables for the **PWR power supply**, **OPT backhaul** configuration, as shown in the following steps. Refer to Figure 3-6.

1. Connect the AC power supply to the power (PWR) interface on the eNB and the other end to a power outlet.
2. Connect the optical fiber cable to the optical (OPT) interface on the eNB.
3. Connect the other end of the optical fiber cable to the Ethernet port on the Ethernet switch.

Figure 3-6: PWR Power Supply, OPT Backhaul Configuration

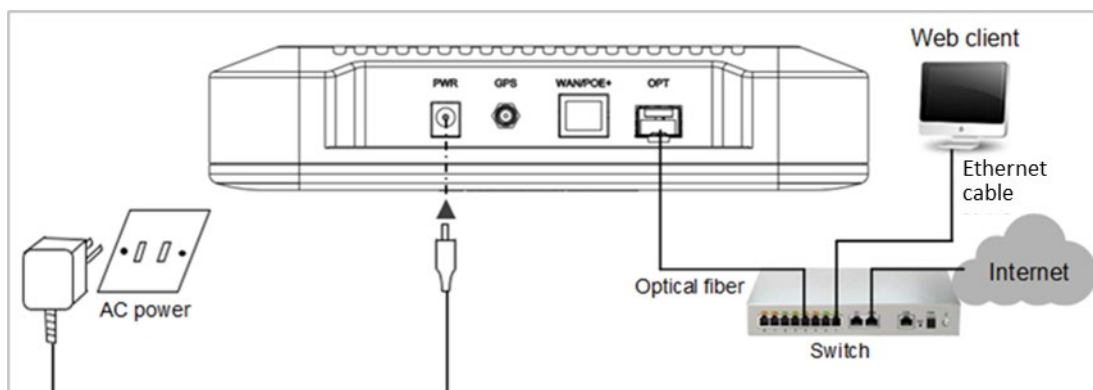

3.3.2 PWR Power Supply, WAN/PoE+ Backhaul Configuration:

Connect the cables for the *PWR power supply*, *WAN/PoE+ backhaul* configuration, as shown in the following steps. Refer to Figure 3-7:

1. Connect the AC power supply to the power (PWR) interface on the eNB and the other end to a power outlet.
2. Connect the Ethernet cable to the WAN/PoE port on the eNB.
3. Connect the other end of the Ethernet cable to the Ethernet port on the Ethernet switch.

Figure 3-7: PWR Power Supply, WAN/PoE+ Backhaul Configuration

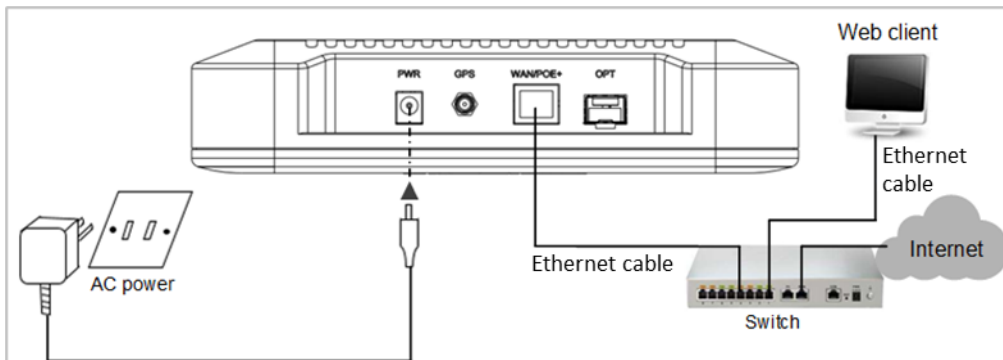

3.3.3 WAN/PoE+ Power Supply and Backhaul Configuration:

Connect the cables for the *WAN/PoE+ power supply and backhaul* configuration, as shown in the following steps. Refer to Figure 3-8.

1. Connect the AC power supply to the LAN switch and the other end to a power outlet.
2. Connect the Ethernet cable to the WAN/PoE+ port on the eNB.
3. Connect the other end of the Ethernet cable to the PoE+ port on the LAN switch.
4. Connect another Ethernet cable to the Ethernet port on the LAN switch.
5. Connect the other end of the Ethernet cable to the Ethernet port on the Ethernet switch.

Figure 3-8: WAN/PoE+ and Power Supply Backhaul Configuration

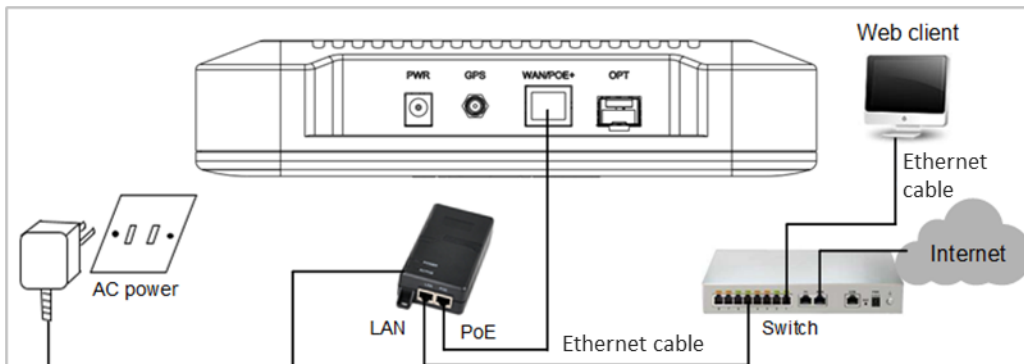

3.4 Power on to Check LED Status

After the Neutrino430 is powered on, check that the LED indicators are lighting as expected: Power is steady green, cell activated is slow flash green, and there are no alarms (Figure 3-9) per previous Table 2-2.

Figure 3-9: Check LEDs



3.5 Configure Basic Parameters

Reference: [eNodeB Configuration Guide](#)

The Neutrino430 eNB can be configured in Single Carrier (SC), Carrier Aggregation (CA), or Dual Carrier (DC)/split mode, depending on which licenses you have purchased, and/or in HaloB mode, which is embedded in the base software. The Neutrino430 also supports CBRS SAS operation.

When first installing and testing the Neutrino430, Baicells recommends configuring the primary cell (Pcell)/Cell 1 carrier settings (without enabling CA, DC, HaloB, or SAS) for simple verification that the new eNB unit is operational. Once it is confirmed to be operational, you can then refer to the appropriate configuration guide(s) for the operating mode you plan to use.

NOTE: For all GUI menus and fields, refer to the following documents on the Baicells website: Baicells.com > Resources > [Documents](#).

- CloudCore Configuration & Network Administration Guide (OMC/BOSS)
 - CPE Configuration Guide
 - eNodeB Configuration Guide
 - Carrier Aggregation & Dual Carrier (Split Mode) Configuration Guide
 - HaloB User Guide
 - SAS Deployment Guide
-

3.5.1 Launch the eNB GUI

Follow the steps below to connect to the Neutrino430 GUI.

- Step 1: Use an Ethernet cable to connect the eNB WAN/PoE+ port to the local network routed to the Internet. The DATA interface is set to DHCP client by default.
- Optionally, you can plug a PC directly into the eNB MGMT port. On your PC you will need to assign a static IP address within the MGMT subnet. The default IP address for the MGMT interface is <http://192.168.150.1/24>.
- Step 2: Open a Web browser, and enter the following IP address: <http://192.168.150.1>.
- Step 3: At the login screen (Figure 3-10), enter the default user name (*admin*) and password (*admin*) and click on *Login* to open the home page.

Figure 3-10: GUI Login

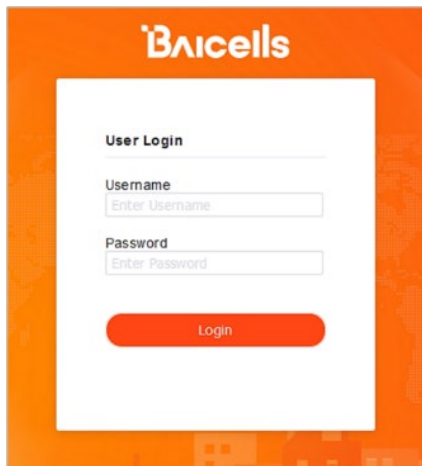

The home page is the *Basic Setting > Basic Info* menu, which reports the current eNB status (Figure 3-11). In [section 3.5.7](#), you will use this page to confirm that the eNB is active.

Figure 3-11: Home Page

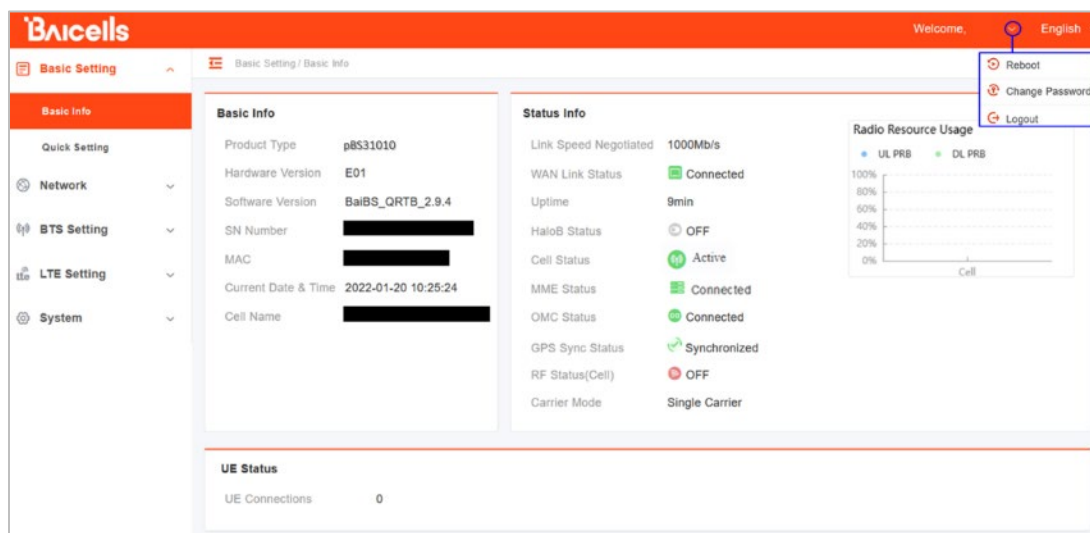

Optionally, you may want to:

1. Change the login password.
2. Confirm the firmware version is the latest available from Baicells; upgrade if needed. Firmware upgrades can be found at Baicells.com > Support > [Firmware](#). See [Section 3.5.2](#) for detailed instructions regarding firmware upgrades.
3. Set the Network Timing Protocol (NTP).

For help, refer to the [CloudCore Configuration & Network Administration Guide](#).

3.5.2 Upgrade Firmware

To ensure you are using the most recent software version before configuring the eNB, follow the steps below.

3.5.2.1 Upgrade Firmware from eNB GUI

1. Download the most recent firmware file from Baicells.com > Support > [Firmware](#), and save on local computer.
2. Go to *System > Upgrade*, and select whether to preserve the current settings.
3. Select *Choose File*, and navigate to the firmware file saved on local computer.

NOTE: The file type is *.IMG

4. Click *Upgrade*.
5. In the pop-up window click *PROCEED*.
6. The base station reboots after approximately three minutes.
7. On the *Basic Setting > Basic Info* page, the upgraded version is displayed in *Software Version*.

3.5.2.2 Upgrade Firmware from the OMC

1. Go to *eNB > Upgrade > Upgrade&Rollback*.
2. Select the correct *Product Type* from the list.
3. Select the checkbox next to the eNB(s) you want to upgrade.
4. In the *New Task* window, select the *Upgrade Type*.
5. In the eNB section, select the checkbox(es) next to the eNB(s) you want to upgrade.
6. Next to *File List*, select/deselect *Retain Configuration*. Under *Select*, choose the software version by clicking in the empty cell (a blue checkmark will appear).
7. Choose the *Execute Type*, which determines when the upgrade will occur.
8. Select *OK*.

3.5.3 Basic Configuration Overview

Figure 3-12 indicates four main steps for basic configuration: network interfaces, management server address, quick settings pertaining to key LTE parameters, and the carrier setting.

Figure 3-12: Configuration Flow

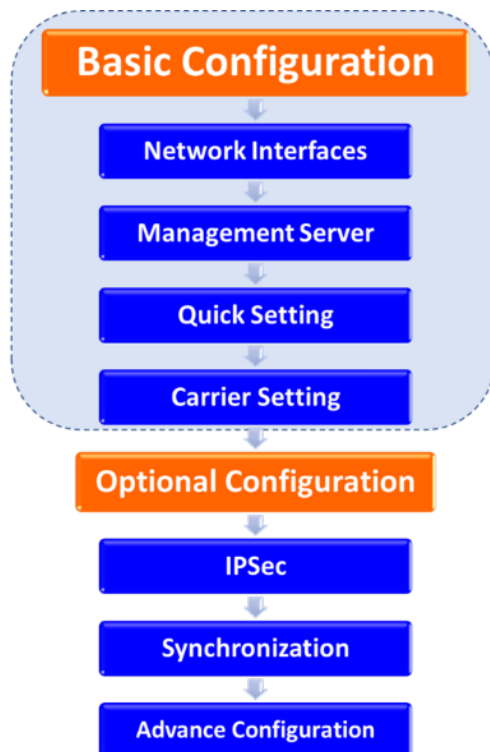

3.5.4 Configure Network Interfaces

The network interfaces defined as part of the initial, basic setup include the WAN/LAN/VLAN interfaces, Dynamic Host Configuration Protocol (DHCP), and the Local Gateway (LGW) mode.

3.5.4.1 WAN/LAN/VLAN

Go to the *Network > WAN/LAN/VLAN* menu (Figure 3-13). The WAN interface is an external communication portal (Internet connection) between the eNB Network Management System (NMS) – in most cases, the CloudCore OMC – and the Mobility Management Entity (MME). If not using CloudCore, the eNB NMS can be a Local OMC or the LTE NMS. The *WAN/LAN/VLAN* fields are described in Table 3-1.

If the *IP Access Mode* field is set to *DHCP* and the *LGW* function is *ON* (section 3.5.3.2), the *Connect Type* field must be modified. The IP address of the eNB will be changed due to the MAC address being changed. Therefore, modify the router server at the same time.

The *LAN Config* interface is used only as a local maintenance port during initial eNB setup and basic configuration; it is not used during normal eNB operation. Enter the IP address and subnet mask address for the local network connection. The default IP address for the *LAN* interface is 192.168.150.1.

NOTE: If the LAN IP address is changed, the eNB will reboot, and you will have to log in to the GUI again.

Figure 3-13: WAN/LAN/VLAN

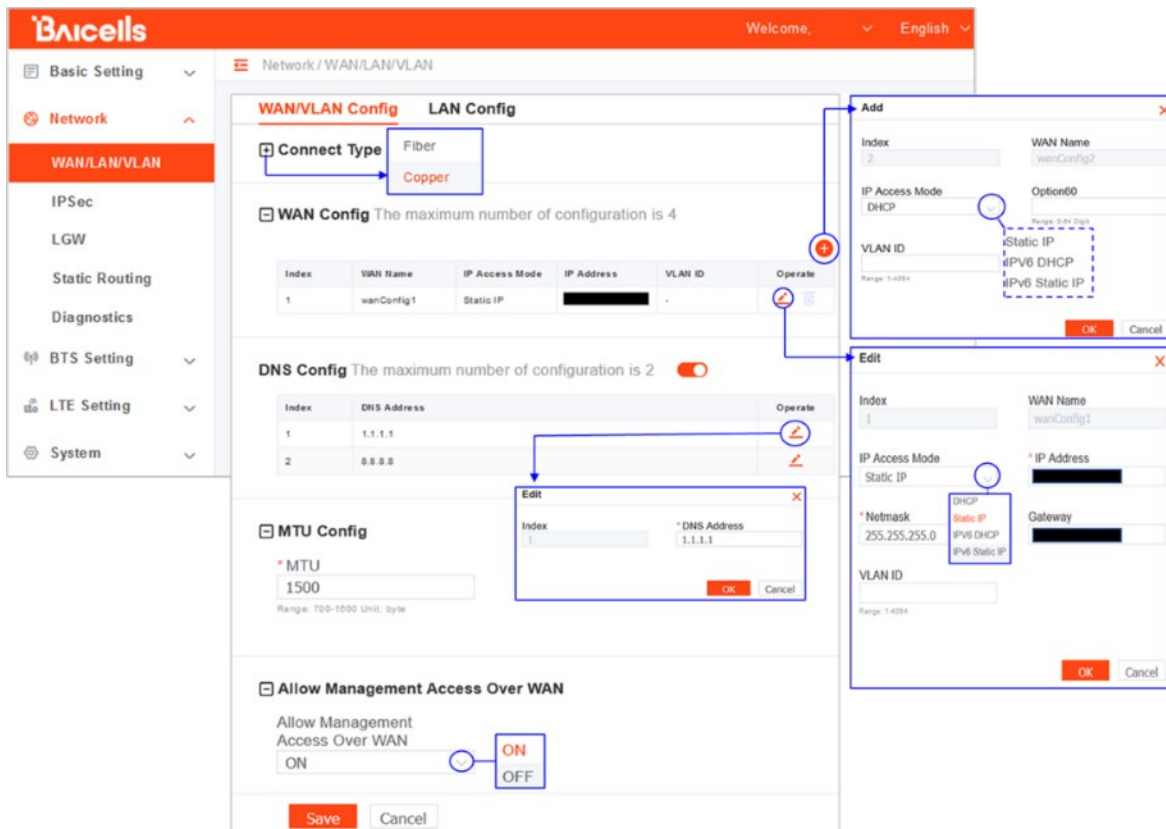

Table 3-1: WAN/LAN/VLAN

Field Name	Description
Allow Management Access Over WAN	Enable or disable the Local Maintenance Terminal connection through the WAN port.
Connect Type	Used to select the type of connection for the eNB (Copper or Fiber)
MTU	Used to specify the maximum size of the network layer protocol data unit that can be communicated in a single network transaction. Range is 700–1600.
DNS Address 1	Used to define the DNS 1 IP address
DNS Address 2	Used to define the DNS 2 IP address
WAN Config	Used to enable the interface. Four IP addresses are the maximum number the eNB supports.
IP Access Mode	Used to select the desired interface protocol: DHCP, Static IP, IPv6 DHCP, or IPv6 Static IP
Current IP	The WAN interface IP address
Option60	Used to differentiate between different terminals when <i>IP Access Mode</i> is set to <i>DHCP</i>
Subnet Mask	Used to define subnet mask address if <i>IP Access Mode</i> is set to <i>Static IP</i>
Prefix	Prefix of IPv6 address for WAN interface if <i>IP Access Mode</i> is set to <i>IPv6 Static IP</i>
Gateway	Used to define gateway address if <i>IP Access Mode</i> is set to <i>Static IP</i>
VLAN ID	Used to configure more IP addresses for the WAN interface through the VLAN when there is a need to transmit multi-types of data.

3.5.4.2 LGW

The Local GateWay (LGW) setting must be configured when using the Baicells CloudCore Evolved Packet Core (EPC). Refer to Figure 3-14 and Table 3-2. You must reboot the eNB when you make changes to these settings.

Figure 3-14: LGW

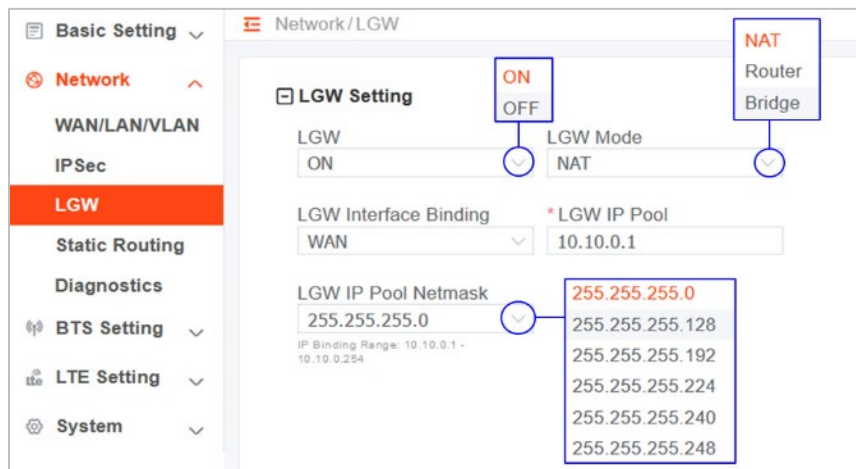

Table 3-2: LGW

Field Name	Description
LGW	On or Off
LGW Mode	Select an option: NAT: Packages from the internal network to the external network need Network Address Translation Router: Select optimized route from the routing table (Figure 3-15) Bridge: Transfer in the data link layer
LGW Interface Binding	The IP address connects to the LGW. Select from configured interfaces. Default is WAN interface. The VLAN interface can also be used to separate different links.
LGW IP Pool	Enter the starting IP address of the dynamic IP address pool
LGW IP Pool Netmask	For example, if the first IP address is 10.10.10.1 and the netmask is 255.255.255.0, the IP address pool includes 255 IP addresses. The options are shown in the pull-down menu. 
Static Address	If <i>LGW Mode = Router</i> (Figure 3-15), set to <i>ON</i> if you want to use a static IP address.
First Address	If <i>LGW Mode = Router</i> and <i>Static Address = ON</i> (Figure 3-15), enter the first static IP address in the range.
Last Address	If <i>LGW Mode = Router</i> and <i>Static Address = ON</i> (Figure 3-15), enter the last static IP address in the range.
IMSI to IP Binding - IMSI	If <i>LGW Mode = Router</i> and <i>Static Address = ON</i> (Figure 3-15), if you want to bind an IMSI number to the IP address, enter the IMSI number.
IMSI to IP Binding - IP	If <i>LGW Mode = Router</i> and <i>Static Address = ON</i> (Figure 3-15), enter the IP address to bind to the IMSI. You can add more than one IP address.

Figure 3-15 LGW = Router



3.5.4.3 Static Routing

When using static routing, go to *Network > Static Routing*. The *Network > Static Routing* landing page has two main sections, *Static Routing Config* and *Validated Route List* (Figure 3-16). The configured static route information is displayed under *Static Routing Config*. To edit a static route in the list, click on the **edit** icon, enter the information, and click *OK*. To add a static route, click on the **Add** icon. Fill in the information and click *OK*. Field descriptions are in Table 3-3.

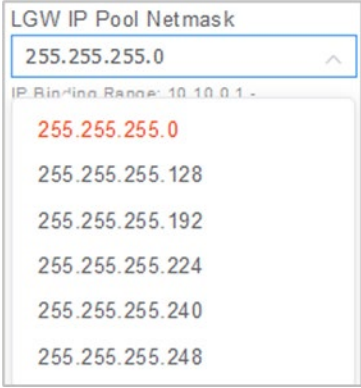
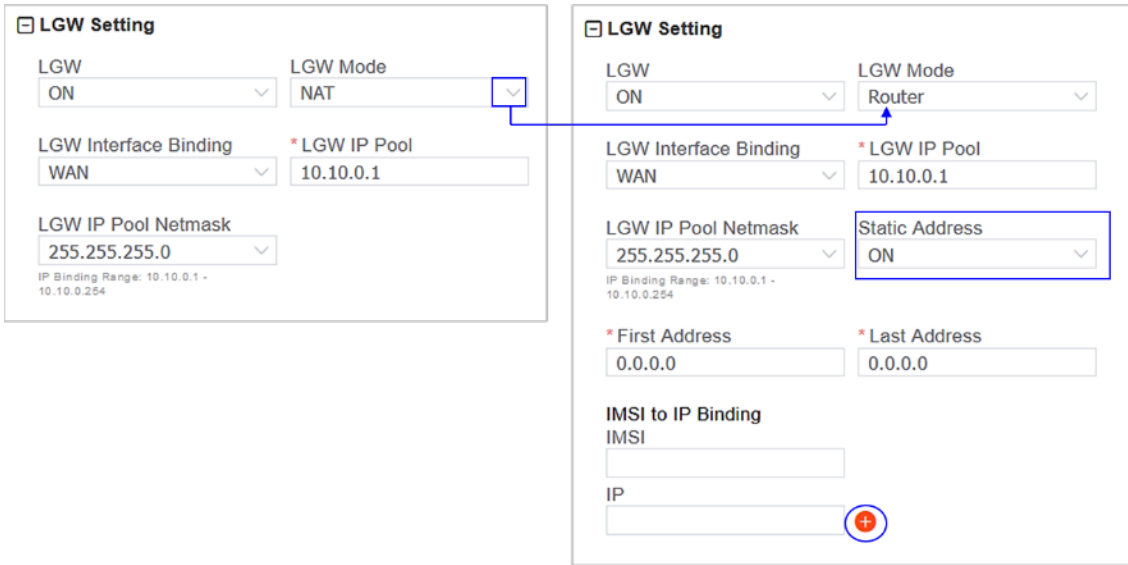
Figure 3-16: Static Routing

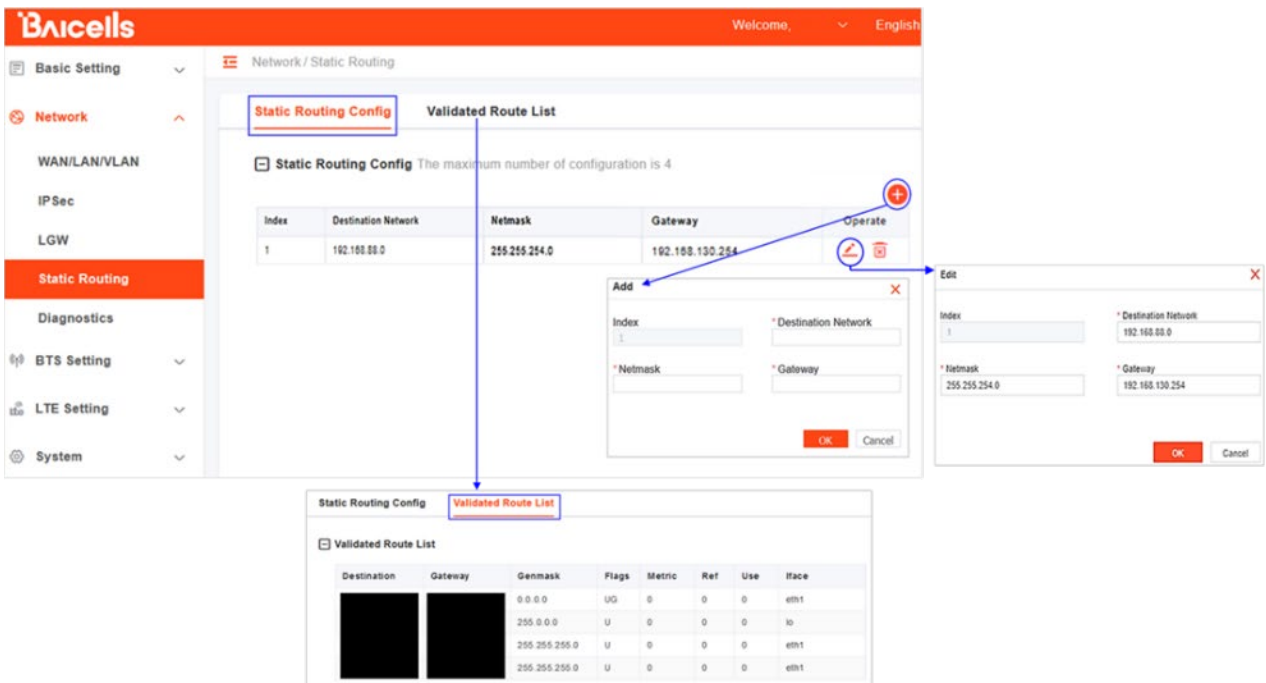

Table 3-3: Static Routing

Field Name	Description
Index	Auto-generated router index number
Enable	Enable/Disable the static route
Destination Network	The destination IP address
Netmask	The destination subnet mask
Gateway	The destination gateway IP address

3.5.5 Configure the Management Server

In the *BTS Setting > Management Server* window, you will enter the network management service (NMS) information (Figure 3-17). When using the Baicells CloudCore to manage the network, in the *http://* field, enter the following URL address and port number:

baiomc.cloudapp.net:48080/smallcell/AcsService

If you are using Local OMC or another NMS, enter its server address and port number. Refer to the field descriptions in Table 3-4.

Figure 3-17: Management Server

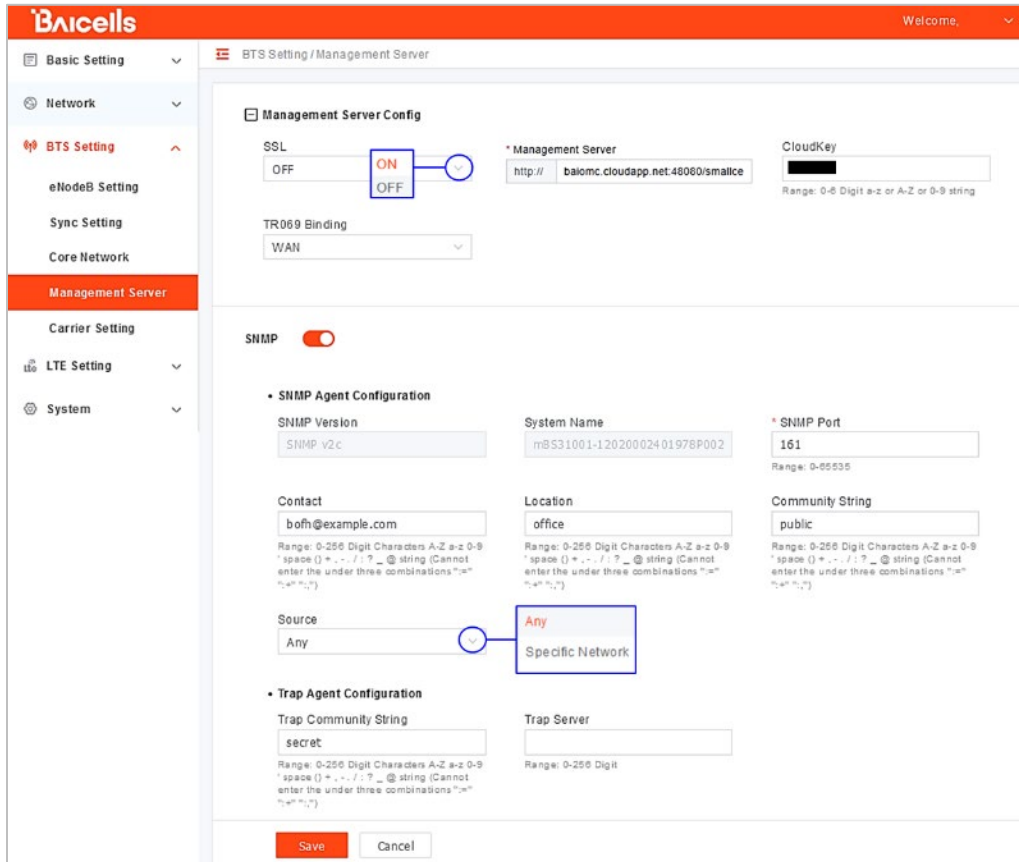



Table 3-4: Management Server

Field Name	Description
SSL	Enable/Disable Secure Socket Layer (SSL) using <i>ON/OFF</i> . When enabled the Management Server field changes to a secure http extension.
Management Server	Enter the management server IP address and port number
CloudKey	Operators using the Baicells CloudCore are provided a unique CloudKey identifier that can be used when configuring CPEs and eNBs. If entered in this field, when the device is powered on it will immediately associate to the operator's OMC account. You can find your CloudKey ID when you log in to the CloudCore. It is displayed in the top bar.
TR069 Binding	Binds TR-069 protocol information to a specific server.
SNMP	Enabled=OFF/ON 
SNMP Agent Configuration	Option available when SNMP option is enabled: <ul style="list-style-type: none"> • SNMP Version • SNMP System Name • SNMP Port • Contact • Location • Community String • Source
Trap Agent Configuration	Option available when SNMP option is enabled: <ul style="list-style-type: none"> • Trap Community String • Trap Server

3.5.6 Configure Quick Settings

Under the *BTS Setting > Quick Setting* window (Figure 3-18) are several important fields you must configure and/or verify. First, if the operator is using the Baicells CloudCore EPC, you must enter a fixed Public Land Mobile Network (PLMN) and MME IP address:

- PLMN = **314030**
- MME IP = **10.3.0.9 and 10.5.0.9**

Do not change these settings except when connecting to a Local (private network) EPC or different vendor's Evolved Packet Core (EPC). Second, you must enter the operator's planned settings for Band, Bandwidth, EARFCN, Cell ID, PCI, TAC, etc. Some *Quick Setting* fields such as *Duplex Mode* and *Frequency* will auto-fill based on the eNB hardware model. Make sure the *Cloud EPC* field is set to *ON* when using the Baicells CloudCore. If you are testing the eNB in a lab environment, turn the power down as low as it will go under the *Power Modify* field.

NOTE 1: If planning to use CBRS SAS, the SAS vendor will determine some of these parameters. Refer to the *SAS Deployment Guide* for more information.

NOTE 2: Neutrino430 does not support SFA = 0.

For a description of all the eNB *Quick Setting* fields, refer to the *eNodeB Configuration Guide*.

Figure 3-18: Quick Setting

The screenshot displays the 'Quick Setting' configuration page in the Baircells management interface. The page is organized into several sections:

- Quick Setting:**
 - Duplex Mode:** TDDMode
 - HaloB:** OFF (with ON/OFF toggle)
 - S1 Connection Mode:** All
 - S1 Link Port:** 36412 (Range: 0-65535)
 - Carrier Mode:** Single Carrier (with dropdown for Single Carrier, Dual Carrier, Carrier Aggregation)
 - Quick Interface Binding:** WAN
 - * TAC:** 1 (Range: 0-65535)
 - Country Code:** Other
 - PLMN:** A table with columns for PLMN ID and Operate. One entry is shown: PLMN ID 314030.
 - MME IP:** A table with columns for MME IP, PLMN, Status, and Operate. Two entries are shown:

MME IP	PLMN	Status	Operate
10.3.0.9	314030	Not Connected	[Operate]
10.5.0.9	314030	Not Connected	[Operate]
- Cell Quick Setting:**
 - Band:** 48
 - Bandwidth:** 20
 - * EARFCN:** 55340 (Range: 55340-56540)
 - Frequency(MHz):** 3560
 - SubFrame Assignment:** 1 (DL:UL = 2:2)
 - Special SubFrame Patterns:** 7
 - * PCI:** 55 (Range: 0-503)
 - * Cell ID:** 135787604 (Range: 0-268435455)
 - RF Status:** OFF
 - Power Modify:** 2 X 30dBm

At the bottom of the configuration area, there are 'Save' and 'Cancel' buttons.

3.5.7 Configure Carrier Setting

Reference: *Carrier Aggregation & Dual Carrier (Split Mode) Configuration Guide*

The *Carrier Setting* menu is used only in the two-carrier Neutrino430 eNB (Figure 3-19). You can set the eNB to run as a single carrier, as two combined carriers using Carrier Aggregation (CA), or as two independent carriers using Dual Carrier (DC)/split mode, depending on which licenses you have purchased. Single carrier (no CA) means only Cell 1 will operate and use only two Radio Frequency (RF) ports instead of four. Operators may need to use this mode if they have limited spectrum or are planning to change to CA or DC mode at a later time when more capacity is needed for the coverage area. Go to *BTS Setting > Carrier Setting* to configure *Carrier Mode*. Click the arrow to view the drop-down menu.

Whenever you change the carrier setting, you must reboot the eNB for the change to take effect.

Figure 3-19: Carrier Setting

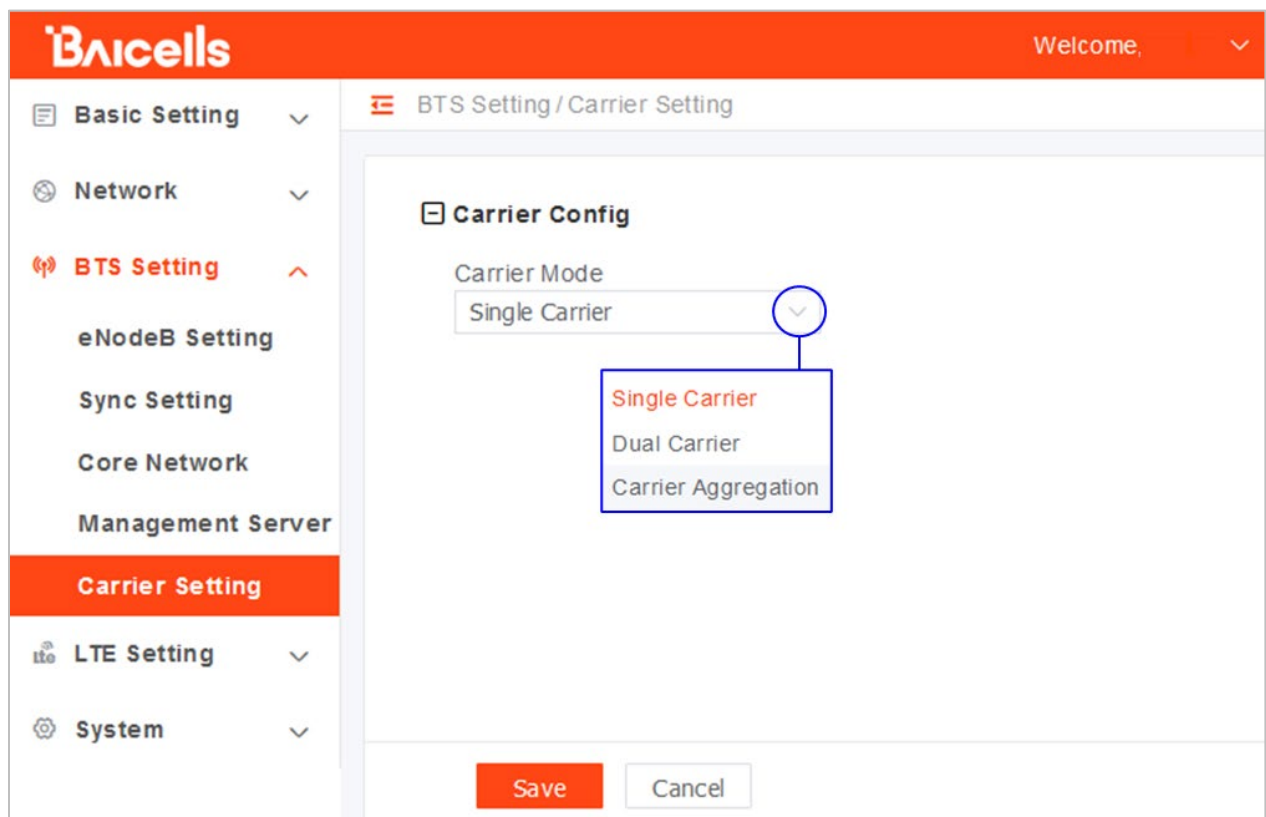

3.5.8 Reboot

Once the basic configuration settings are saved, reboot the eNB. There are two options for rebooting in the eNB GUI. From the landing page of the eNB GUI, navigate to *System > Reboot*, or select *Reboot* under the *Welcome* banner (Figure 3-20).

Figure 3-20: Reboot

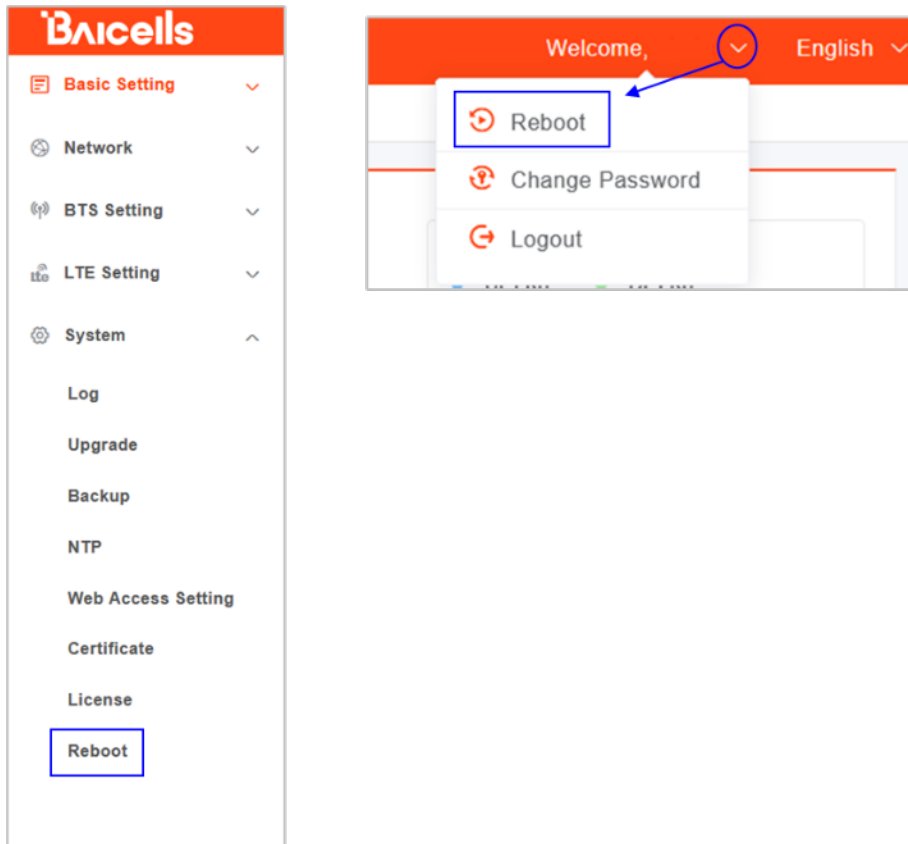

3.5.9 Verify eNB Operational Status

When the eNB is finished rebooting, check the eNB status using the eNB GUI and the OMC:

NOTE: Once the eNB is mounted at its intended destination and powered on, recheck the status settings.

- **eNB GUI:** Go to *Basic Setting > Basic Info* and check the *Cell Status* field (Figure 3-21). It should show *Active*. Also, check that *GPS Sync* is reported as *Synchronized*.
- **OMC:** Go to *eNB > Monitor* to see if the *Cell Status* shows *Active* and the *Sync Status* shows *GPS Synchronized* (Figure 3-22).

NOTE: Ensure you have selected *ALL* in the display settings window in the *OMC > eNB > Monitor* page to view *Cell Status* and *Sync Status* as shown in Figure 3-23.

Figure 3-21: Cell Status (eNB GUI)

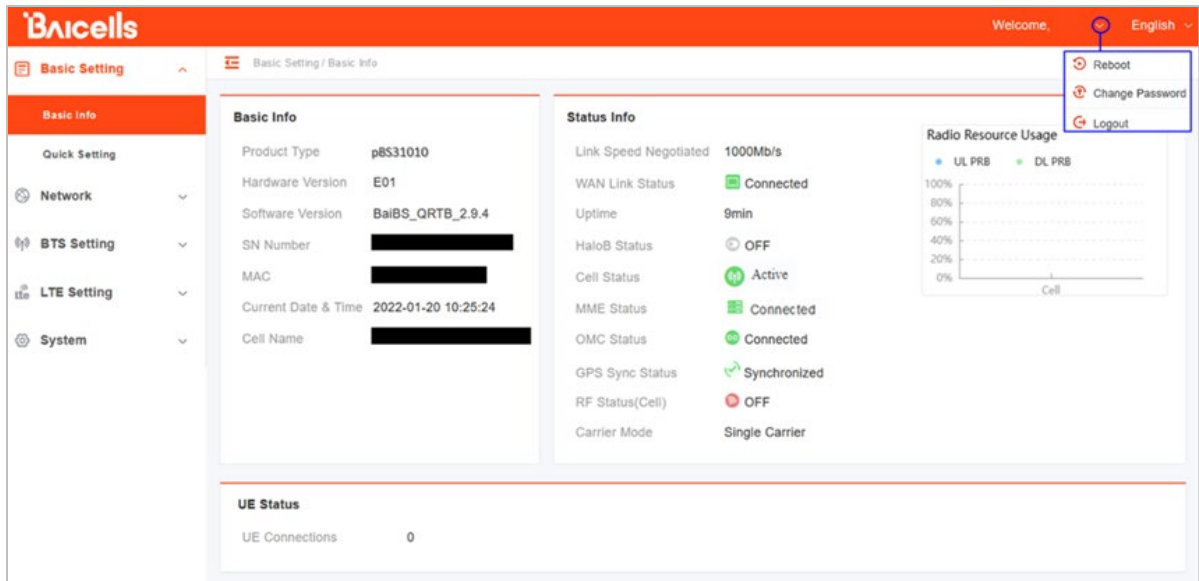

Figure 3-22: Cell Status (OMC)

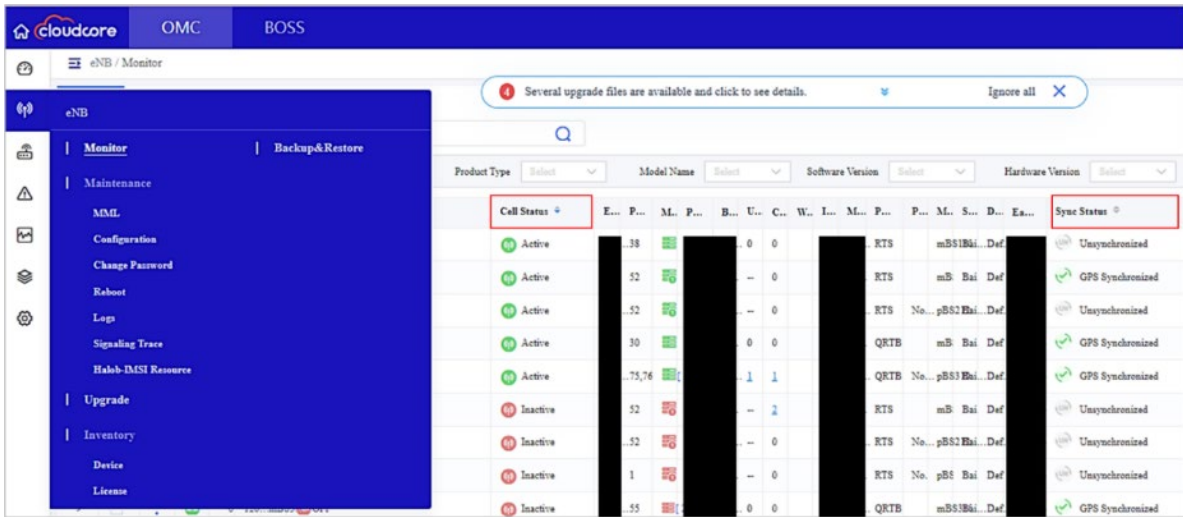
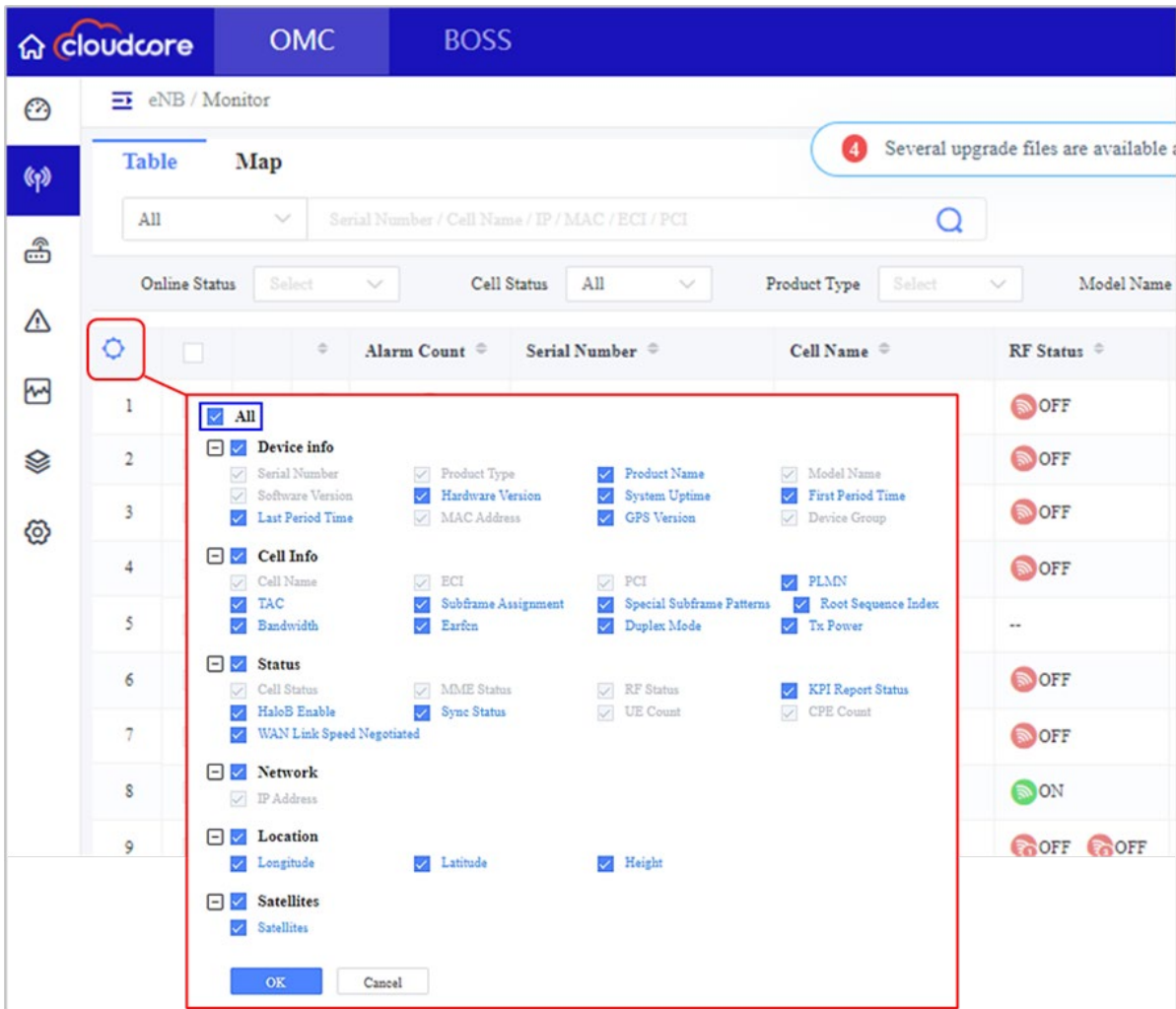

Figure 3-23: OMC > eNB > Monitor > Display Settings



Before commercial operation, Baicells recommends implementing cell site acceptance testing of a new site to ensure the service meets expectations, to document network speeds at various locations in the cell, and to verify RF coverage.

Appendix: Regulatory Compliance

FCC Compliance

This device complies with part 15 of the FCC Rules. Operation is subject to the following two conditions: (1) This device may not cause harmful interference, and (2) this device must accept any interference received, including interference that may cause undesired operation. Any Changes or modifications not expressly approved by the party responsible for compliance could void the user's authority to operate the equipment.

This equipment has been tested and found to comply with the limits for a Class B digital device, pursuant to part 15 of the FCC Rules. These limits are designed to provide reasonable protection against harmful interference in a residential installation. This equipment generates, uses, and can radiate radio frequency energy and, if not installed and used in accordance with the instructions, may cause harmful interference to radio communications. Operation of this equipment in a residential area is likely to cause harmful interference, in which case the user will be required to correct the interference at his own expense.



WARNING: This equipment complies with FCC radiation exposure limits set forth for an uncontrolled environment. This equipment should be installed and operated with a minimum distance of 20 inches (50 cm) between the radiator and your body.

ISED Compliance

This device complies with Innovation, Science, and Economic Development Canada license-exempt RSS standard(s).

Operation is subject to the following two conditions: (1) This device may not cause interference, and (2) This device must accept any interference, including interference that may cause undesired operation of the device.

The antenna(s) used for this transmitter must be installed to provide a separation distance of at least 20 inches (50 cm) from all persons and must not be collocated or operating in conjunction with any other antenna or transmitter, End-Users must be provided with transmitter operation conditions for satisfying RF exposure compliance.