

Buicells

Nova430i

Outdoor 4x250mW

Two-Carrier

TDD eNodeB

Installation Guide

QRTB 2.9.4

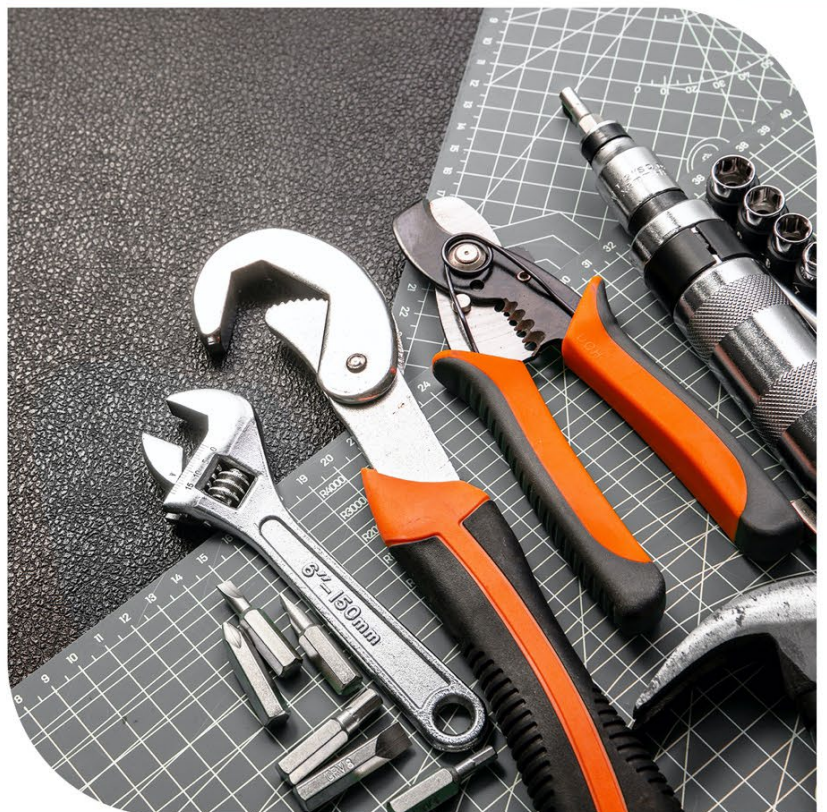
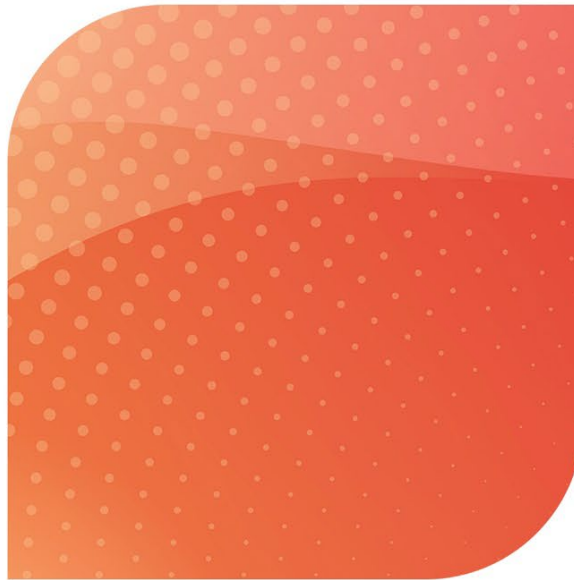

March 2022

Version 1.01

About This Document

This document is intended for personnel who will be installing the Baicells Nova430i Outdoor 4x250mW eNodeB (eNB) product. The product overview is followed by the procedures for properly installing, performing basic configuration, and verifying the eNB is operational. Please be advised that only personnel with the appropriate electrical skills and experience should install this device. This document is based on software version BaiBS_QRTB_2.9.4. The Nova430i part number is pBS3101S.

Terms used in this document or related to LTE are listed in alphabetical order and described in [Acronyms and Abbreviations](#), which can be found at Baicells.com > Resources > [Documents](#).

Copyright Notice

Baicells Technologies, Inc., copyrights the information in this document. No part of this document may be reproduced in any form or means without the prior written consent of Baicells Technologies, Inc.

Disclaimer

The information in this document is subject to change at any time without notice. For more information, please consult with a Baicells technical engineer or the support team. Refer to the "Contact Us" section below.

Disposal of Electronic and Electrical Waste



Pursuant to the WEEE EU Directive, electronic and electrical waste must not be disposed of with unsorted waste. Please contact your local recycling authority for disposal of this product.

Revision Record

Date	Version	Description	SMEs/Contributors	Author/Editor
04-Mar-2022	1.01	Initial release for QRTB 2.9.4	Warren Lai, Sonny May, Abel Lamas	Catherine Philley

Resources

- **Documentation** - Baicells product data sheets, this document, and other technical manuals can be found at Baicells.com > Resources > [Documents](#).
- **Support** - How to open a support ticket, process an RMA, and the Support Forum are at Baicells.com > [Support](#).

Contact Us

Baicells Technologies North America, Inc. North America	
Address:	5700 Tennyson Pkwy, #300, Plano, TX 75024, USA
Phone:	+1-888-502-5585
Email:	sales_na@Baicells.com or support_na@Baicells.com
Website:	https://na.Baicells.com

Safety Information

For the safety of installation personnel and the protection of the equipment from damage, please read all safety warnings. If you have any questions concerning the warnings, before installing or powering on the base station, contact the [Baicells support team](#).



WARNING: IMPORTANT SAFETY INSTRUCTIONS

This warning symbol means danger. You are in a situation that could cause bodily injury. Before you work on any equipment, be aware of the hazards involved with electrical circuitry, and be familiar with standard practices for preventing accidents



WARNING: Read the installation instructions before you connect the system to its power source.



WARNING: Equipment installation must comply with local and national electrical codes.



WARNING: This product relies on the existing building or structure for short-circuit (overcurrent) protection. Ensure that the protective device is rated no greater than 20A.



WARNING: Do not operate this wireless network device near unshielded blasting caps or in an explosive environment unless the device has been modified and qualified for such use.



WARNING: To comply with the United States Federal Communications Commission (FCC) radio frequency (RF) exposure limits, antennas should be located at a minimum of 20 centimeters (7.9 inches) or more from the body of all persons.

Table of Contents

1 Overview	7
1.1 Introduction.....	7
1.2 Features.....	8
2 Installation Preparation	10
2.1 Materials	10
2.2 LEDs and Interfaces.....	12
2.3 Location and Environment	13
2.4 CloudCore Account	13
3 Installation.....	14
3.1 Process Overview.....	14
3.2 Install eNB on Pole or Wall	14
3.2.1 Install on Pole.....	14
3.2.2 Install on Wall.....	16
3.3 Connect Cables	17
3.3.1 Cable Laying Requirements.....	17
3.3.2 Connect Ethernet Cable.....	18
3.4 eNB Grounding	18
3.4.1 Connect Grounding Cables	18
3.4.2 Pole Grounding.....	19
3.5 Maintenance Chamber Waterproofing.....	20
3.6 Power on to Check LED Status.....	20
3.7 Configure Basic Parameters.....	21
3.7.1 Launch the eNB GUI	21
3.7.2 Upgrade Firmware.....	23
3.7.3 Basic Configuration Overview	24
3.7.4 Configure Network Interfaces.....	24
3.7.5 Configure the Management Server	29
3.7.6 Configure Quick Settings.....	31
3.7.7 Configure Carrier Setting	32
3.7.8 Reboot	33
3.7.9 Verify eNB Operational Status	34
Appendix: Regulatory Compliance.....	37
FCC Compliance.....	37
ISED Compliance.....	37

List of Figures

Figure 1-1: Nova430i eNB.....	7
Figure 1-2: Network Structure	7
Figure 2-1: Packout.....	10
Figure 2-2: LEDs and Interfaces.....	12
Figure 2-3: CloudCore Login Page	14
Figure 3-1: Installation Process Overview.....	14
Figure 3-2: Attach Bracket to Pole.....	15
Figure 3-3: Attach eNB to Bracket	15
Figure 3-4: Completed Installation.....	15
Figure 3-5: Mark and Drill Holes	16
Figure 3-6: Attach With Expansion Bolts	16
Figure 3-7: Completed Installation.....	17
Figure 3-8: Connect Cables and Grounding Screws	18
Figure 3-9: Pole Grounding	19
Figure 3-10: Check LEDs	20
Figure 3-11: GUI Login	22
Figure 3-12: Home Page	22
Figure 3-13: Configuration Flow.....	24
Figure 3-14: WAN/LAN/VLAN	25
Figure 3-15: LGW.....	26
Figure 3-16: LGW = Router.....	28
Figure 3-17: Static Routing.....	28
Figure 3-18: Management Server	30
Figure 3-19: Quick Setting	32
Figure 3-20: Carrier Setting.....	33
Figure 3-21: Reboot.....	34
Figure 3-22: Cell Status (eNB GUI).....	35
Figure 3-23: Cell Status (OMC).....	35
Figure 3-24: OMC > eNB > Monitor > Display Settings.....	36

List of Tables

Table 2-1: Materials.....	11
Table 2-2: Installation Tools	11
Table 2-3: LEDs	12
Table 2-4: Interfaces	13
Table 2-5: Environment Specifications	13
Table 3-1: WAN/LAN/VLAN.....	25
Table 3-2: LGW	26
Table 3-3: Static Routing	29
Table 3-4: Management Server	30

1 Overview

1.1 Introduction

The Baicells Nova430i (Figure 1-1) is an advanced two-carrier outdoor eNodeB (eNB) that is compliant with Third-Generation Partnership Project (3GPP) on Long-Term Evolution (LTE) Time Division Duplex (TDD) technology. This 4x250mW eNodeB can operate in Carrier Aggregation (CA) mode or Dual Carrier (DC)/split mode. The Nova430i supports broadband data access, providing various data service transformation and transmission capabilities to enable outdoor wireless coverage. This eNodeB can be used by operators to improve capacity and throughput while eliminating existing dead zones.

Figure 1-1: Nova430i eNB



The network structure of the Nova430i is shown in Figure 1-2.

Figure 1-2: Network Structure

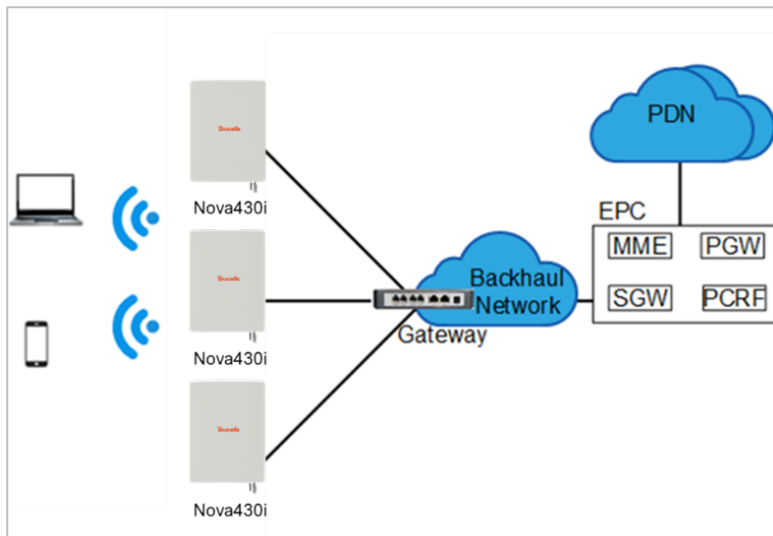

As a two-carrier eNB, the Nova430i hardware unit contains two separate eNBs inside one shell. Having two carriers provides versatile options in how you operate the eNB. The available operating modes are described in the next section, *Features*.

The Nova430i's primary cell (Pcell) is referred to as Cell 1. The secondary cell (Scell) is referred to as Cell 2. Each eNB comes pre-configured to simplify the installation. Baicells provides operators with local and Web-based Graphical User Interface (GUI) software applications to configure and manage individual eNBs and Customer Premise Equipment (CPE).

Additionally, Baicells offers a centralized Software-as-a-Service (SaaS) solution called CloudCore. CloudCore includes all of the essential LTE Evolved Packet Core (EPC) network functions, an Operations Management Console (OMC) for managing multiple sites across the network, and a Business and Operation Support System (BOSS) for subscriber management.

In this document, you will find a general description, guidelines, and procedures for installing, entering basic configuration information, and verifying the operational status of the Nova430i eNB.

1.2 Features

The two-carrier Nova430i eNB can operate in one of several modes:

- Single Carrier (SC)
- Carrier Aggregation (CA) mode (based on software license)
- Dual Carrier (DC)/split mode (based on software license)
- HaloB mode (embedded in the base software)
- Citizens Broadband Radio System (CBRS) Spectrum Access System (SAS)

SC describes a scenario where the operator wishes to use only one of the two available cells in the eNB. This may be necessary for operators who have limited licensed spectrum or who are planning to use the second carrier later as their network grows. In SC mode, only the primary cell (Pcell), *aka* Cell 1, is used.

CA provides the ability to aggregate channels from across the full CBRS range, even channels that are not adjacent. Using CA essentially doubles the downlink capacity when all users have CAT6/7 or later customer premise equipment (CPE).

DC (split sector) mode enables the operator to run the Nova430i as two independent carriers for split sector coverage.

HaloB allows the eNB to function with embedded Mobility Management Entity (MME) capabilities on board so that the eNB operates independently from the usual cloud connection.

CBRS SAS is a multi-vendor Spectrum Access System database where CBRS spectrum use is managed dynamically across operators. The CBRS band covers 3.55–3.70 GHz. Operators must sign up with a SAS provider, which handles the dynamic frequency assignment and release process. Baicells provides FCC Part 96 certified eNBs, including the Nova430i, and CPEs that operate within the Part 96 rules for CBRS. The Baicells eNBs and CPEs use a Domain Proxy (DP) to connect to the SAS server by leveraging the existing connection with the OMC.

NOTE 1: Legacy Gen 1 CPEs do not support SAS.

NOTE 2: This installation guide only covers the basic configuration of a single cell for verifying that the eNB unit is operational during the process of installation. More detailed configuration guides are available on the Baicells website:

Baicells.com > Resources > *Documents*:

- CloudCore Configuration & Network Administration Guide (OMC/BOSS)
 - CPE Configuration Guide
 - eNodeB Configuration Guide
 - Carrier Aggregation & Dual Carrier (Split Mode) Configuration Guide
 - HaloB User Guide
 - SAS Deployment Guide
-

In addition to the Nova430i eNB's two carriers and multiple operating modes, the following is a list of other key features. The Nova430i datasheet providing technical specifications is kept up-to-date on the [Baicells website](#).

- Supports standard LTE TDD band 48, and partial bands 42 and 43 (3550–3700 MHz)
- Complies with 3GPP Release 15 standards
- Supports 5/10/15/20 MHz bandwidth per carrier
- Provides excellent Non-Line-of-Sight (NLOS) coverage
- Peak rate is a configurable parameter using special Subframe Assignment (SA):
 - 2x20 MHz, per carrier:
 - SA1: DL 80 Mbps, UL 28 Mbps
 - SA2: DL 110 Mbps, UL 14 Mbps
 - 2x10 MHz, per carrier:
 - SA1: DL 40 Mbps, UL 14 Mbps
 - SA2: DL 55 Mbps, UL 7 Mbps
- Supports 96 concurrent users per carrier [x2 carriers (96+96) if operating in DC mode; upgradeable to higher capacity in future software releases
- Supports TR-069 network management interface
- Can be accessed via GUI-based local and remote web management
- Connects to any IP-based backhaul, including public transmission
- Is lightweight and uses low power consumption to reduce OPEX
- Compact, plug-and-play device with Self-Organizing Network (SON) capabilities
- Can be used for Internet of Things (IoT) with all mainstream Evolved Packet Core (EPC) vendors
- Ensures secure protection against illegal intrusion
- Integrated high-gain internal antenna
- Compact, all-in-one design of internal antenna and GPS
- Integrated small cell form-factor for quick and easy installation
- Configured out-of-the-box to work with Baicells CloudCore

- GUI-based remote Web management using Baicells Operations Management Console (OMC)
- Supports both Carrier Aggregation (CA) and Dual Carrier (DC) modes
- Embedded HaloB ("lite" EPC) solution
- Supports Citizens Broadband Radio Service (CBRS) with dual carrier
- Built-in GPS synchronization
- Built-in Dynamic Host Configuration Protocol (DHCP) Server, DNS Client, and Network Access Translation (NAT) functionality, providing strong high-speed routing
- Supports Transparent Bridge Mode

2 Installation Preparation

2.1 Materials

Check the Nova430i package to ensure it contains the primary components in the packout (Figure 2-1). In addition to industry-standard tools, you will need the materials described in Table 2-1 and the tools described in Table 2-2 during the installation.

Figure 2-1: Packout

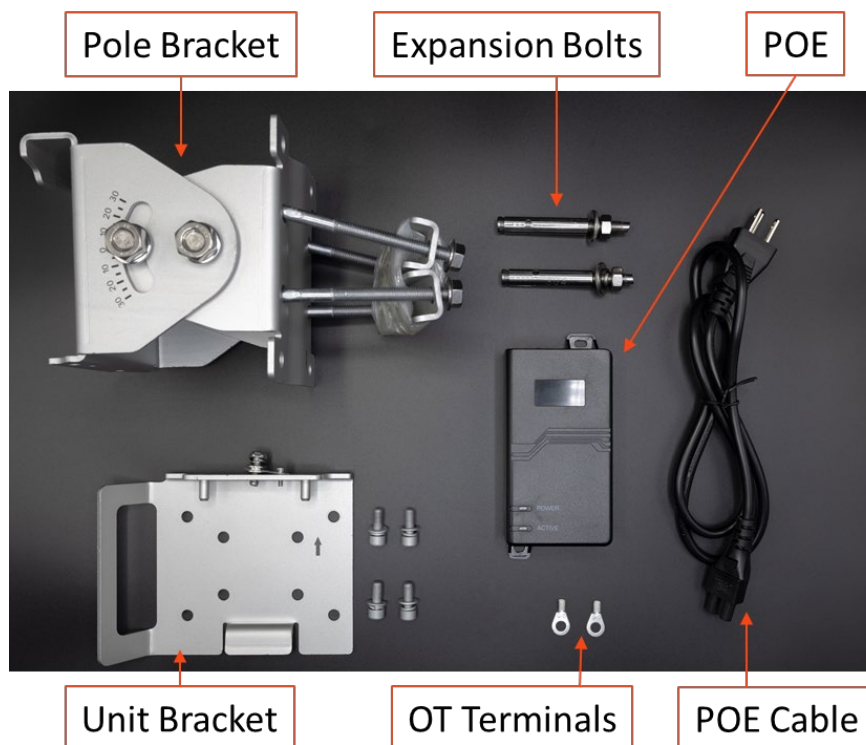

Table 2-1: Materials

Item	Description
Power cable	< 16 AWG, e.g., 14 AWG, shorter than 330 feet (100 meters)
Power plug	The plug that connects the power cable to the electricity supply
Ethernet cable	Outdoor CAT6, shorter than 109 yards (100 meters) It is suggested that the diameter of the cable is 7 mm ± 1 mm.
Ground cable	If the length of lead is more than 10 meters, 6 AWG (10 mm ²) grounding cable should be used.

Table 2-2: Installation Tools

			
Level bar	Marker pen	Knife	Pliers
			
Wrench	Percussion drill and drill heads	Hammer	Phillips-head screwdriver
			
Cable vice (crimper)	Tape measure	0.05 cm (5 mm) L-shape Allen wrench	T7 screwdriver head

2.2 LEDs and Interfaces

Figure 2-2, Table 2-3, and Table 2-4 explain the eNB's LED status indicators and interfaces.

Figure 2-2: LEDs and Interfaces



Table 2-3: LEDs

LED	Color	Status	Description
PWR	Green	Steady on	Power is on
		OFF	No power supply
CELL1	Green	OFF	CELL1 is inactive
		Fast flash: 0.1 s on, 0.1 s off	CELL1 is deactivated
		Slow flash: 1 s on, 1 s off	CELL1 is activated
CELL2	Green	OFF	CELL2 is inactive
		Fast flash: 0.1 s on, 0.1 s off	CELL2 is deactivated
		Slow flash: 1 s on, 1 s off	CELL2 is activated
ALM	Red	Steady on	Hardware alarm
		OFF	No alarm

Table 2-4: Interfaces

Interface Name	Description
ETH	RJ-45 interface (FE/GE) Used for power supply, debug or data backhaul. PoE++, complies with IEEE 802.3bt standard

2.3 Location and Environment

The Nova430i can be installed on a pole or a wall. For the best signal coverage, place the eNB in an unobstructed location. In addition to network planning, when determining where to place the eNB, you need to consider the best location for signal coverage. Avoid locating the eNB in areas where there may be extreme temperatures, harmful gases, unstable voltages, volatile vibrations, loud noises, flames, explosives, or electromagnetic interference (e.g., large radar stations, transformer substations). Avoid areas prone to impounded water, soaking, leakage, or condensation. Environmental specifications are shown in Table 2-5.

Table 2-5: Environment Specifications

Item	Description
Operating Temperature	-40°F to 131°F / -40°C to 55°C
Storage Temperature	-49°F to 158°F / -45°C to 70°C
Humidity	5% to 95% RH
Atmospheric Pressure	70 kPa to 106 kPa
Safety voltage	42 V to 58 V

2.4 CloudCore Account

The Baicells CloudCore includes the Evolved Packet Core (EPC), managed by Baicells, and two operator applications, Operations Management Console (OMC) to manage network elements, and Business and Operation Support System (BOSS) to manage subscribers. If you have not already set up a Baicells CloudCore account, follow the steps below.

- Step 1: Open a web browser, and enter the CloudCore address (Figure 2-3):
<https://cloudcore.cloudapp.net/cloudcore/>
- Step 2: Click on the *Sign up* button.
- Step 3: Complete the mandatory fields, and again click on *Sign up*.

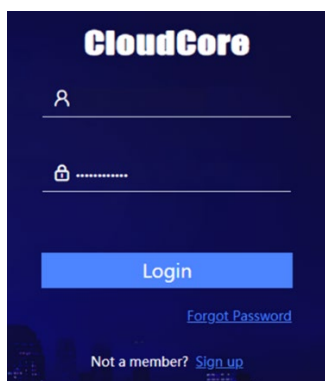
Figure 2-3: CloudCore Login Page

You will receive an email from Baicells. Click on the CloudCore link to go to the login page.

Enter your login user name (email address) and password to authenticate.

3 Installation

3.1 Process Overview

Figure 3-1 provides an overview of the installation process.

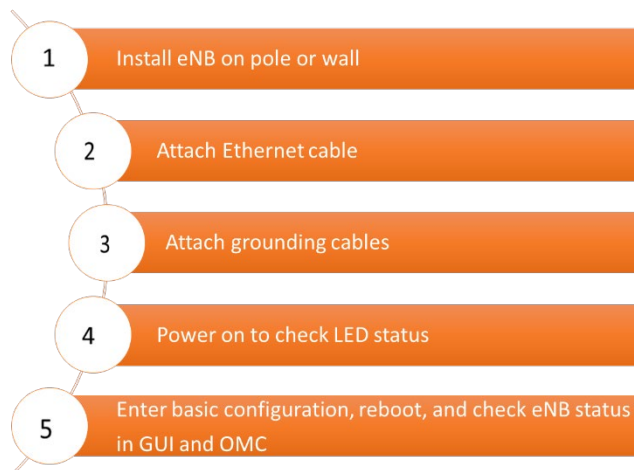
Figure 3-1: Installation Process Overview

3.2 Install eNB on Pole or Wall

3.2.1 Install on Pole

The eNB mounting bracket is assembled in manufacturing before packing. The only action required by the installer is to attach the assembly to the pole.

Check to ensure the diameter of the pole is in the range of 1.6–2.8 in (40–70 mm). The position of the eNB on the pole should be at least 47 in (120 cm) in height. Follow the steps below to install the Nova430i eNB on a pole.

1. Place the bracket on the pole and tighten the hex nuts on the mounting clamps (Figure 3-2).

NOTE: The arrow must be pointing upward.

Figure 3-2: Attach Bracket to Pole

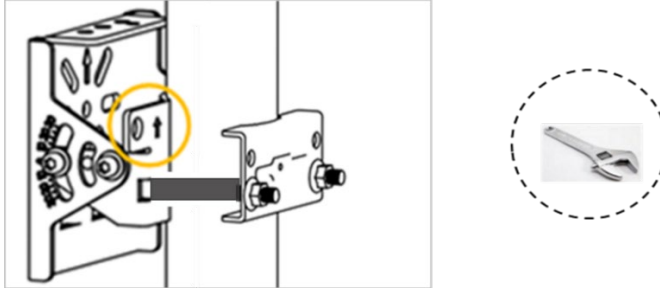

2. Using the two pins on the bracket on the back of the eNB, attach the eNB to the mounting bracket on the pole. Push the eNB until the hook is firmly attached to the mounting bracket (Figure 3-3).

Figure 3-3: Attach eNB to Bracket

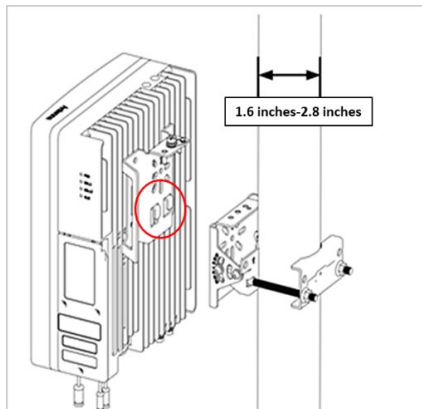

3. Tighten the bolt on the top of the bracket using a Phillips-head screwdriver to complete the installation (Figure 3-4).

Figure 3-4: Completed Installation

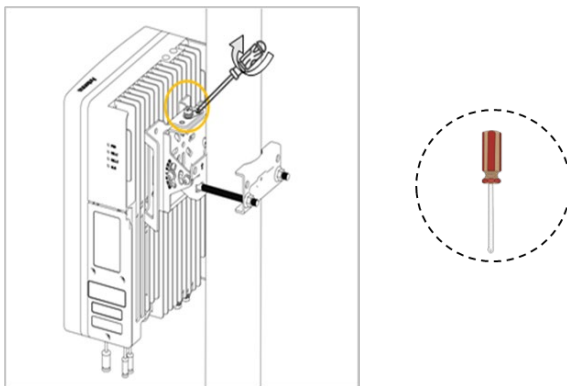

4. After installation is complete, adjust the eNB to a proper angle by tilting.

3.2.2 Install on Wall

Ensure that the wall can bear at least four times the weight of the eNB. Follow the steps below to install the Nova430i eNB on a wall.

1. Take apart the assembled installation bracket.
2. Place the installation bracket on the wall with the arrow facing upward, as shown in Figure 3-5. Mark the drilling locations using a pencil or marker.
3. Drill two holes in the wall to match the size of the wall bracket holes (Figure 3-5).

Figure 3-5: Mark and Drill Holes

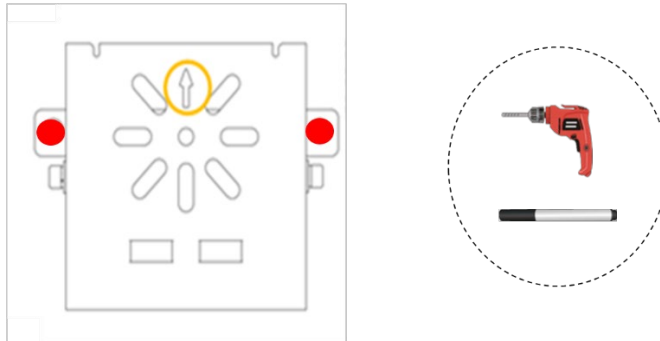

4. Check the up/down direction of the installation bracket, and then attach to the wall using expansion bolts (Figure 3-6).

Figure 3-6: Attach With Expansion Bolts

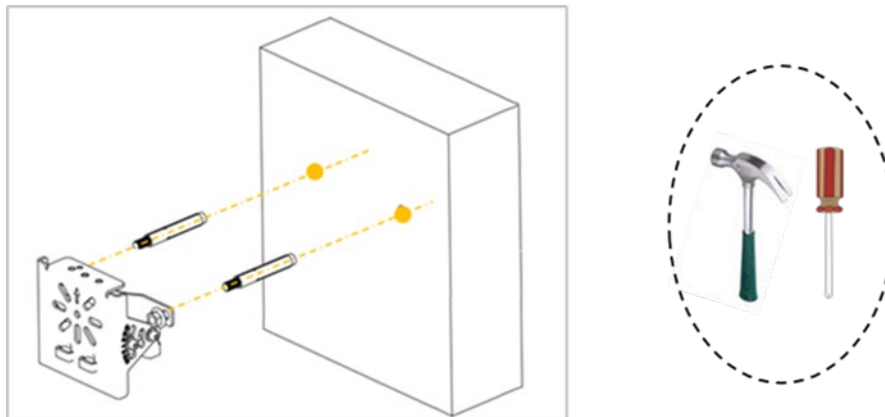

- Using the two pins on the bracket on the back of the eNB, attach the eNB to the mounting bracket on the wall. Push the eNB until the hook is firmly attached to the mounting bracket. Tighten the bolt on the top of the bracket using a Phillips-head screwdriver to complete the installation (Figure 3-7).

Figure 3-7: Completed Installation

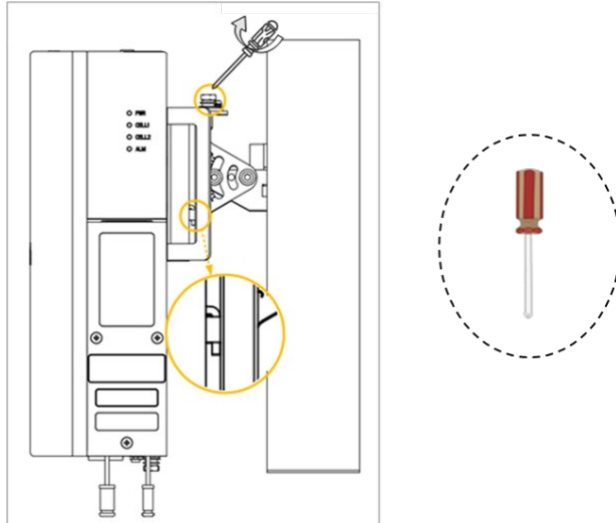

3.3 Connect Cables



WARNING: Ensure the antenna is connected before powering up the eNB. The wireless signal transmission power can cause bodily injury and damage to the eNB and Radio Frequency (RF) power amplifier devices.

3.3.1 Cable Laying Requirements

General requirements:

- Bending radius of antenna feeder cable: 7/8 in > 9.84 in (250 mm), 4/5 in > 14.96 in (380 mm)
- Bending radius of jumper cable: 1/4 in > 1.38 in (35 mm), 1/2 in (super soft) > 1.97 in (50 mm), 1/2 in (ordinary) > 5 in (127 mm)
- Bending radius of power cable and grounding cable: > triple the diameter of the cable
- Bind the cables according to the type of cable; intertwining and crossing are forbidden.
- An identification label should be attached after the cable has been laid.

Grounding cable laying requirements:

- The grounding cable must connect to the grounding point.
- The grounding cable must be separated from the signal cables, of enough distance to avoid signal interference.

3.3.2 Connect Ethernet Cable

Refer to Figure 3-8 to complete the Ethernet cable connection.

1. Connect the Ethernet cable to the **ETH** interface in the wiring cavity.
2. Lay the Ethernet cable along the wire groove, and stretch out the wiring cavity from **ETH** hole.
3. The Ethernet cable connects to the PoE interface of the PoE adapter.
4. The LAN interface of the PoE adaptor connects to a LAN switch or a router for maintenance and backhaul.

NOTE: The PoE adaptor must be placed in the distribution box for waterproofing.

3.4 eNB Grounding

3.4.1 Connect Grounding Cables

Prepare the grounding cable according to the actual measurements and requirements of the specific installation site. The Nova430i eNB has two grounding screws located on the bottom of the unit, as shown in Figure 3-8. Follow the steps below the figure to connect the ground cable.

NOTE: All Nova eNBs have a floating ground on the power system.

1. Unscrew one grounding screw, connect one end of the ground cable to the grounding screw, and retighten the screw.
2. Repeat **step 1** for the second grounding screw.
3. Once the eNB is installed at the outdoor location, the other end of the ground cable needs to connect to a good earth grounding point.

Figure 3-8: Connect Cables and Grounding Screws

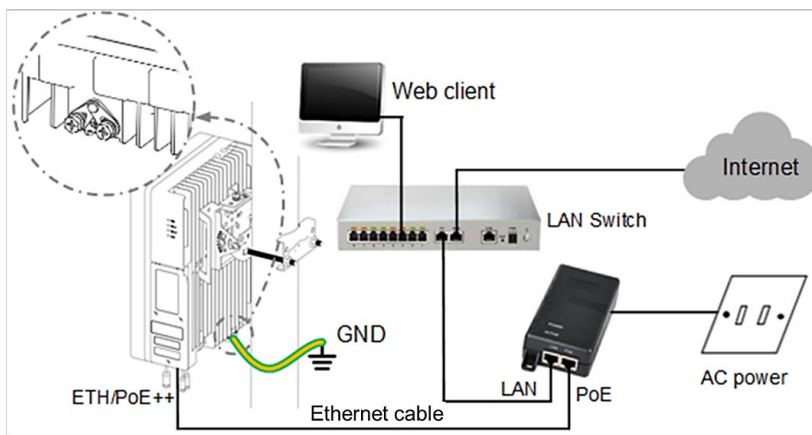

Before installing the eNB at its final destination, perform the steps in [sections 3.6](#) and [3.7](#). Upon successful testing, the eNB will be ready for installation at the cell site. Seal and weatherproof all the connection points, and rustproof where needed.

3.4.2 Pole Grounding

The purpose of pole grounding is to protect the equipment as much as possible from potential damage of lightning overvoltage. However, the interfaces between the eNB and the outside world mainly include power system, grounding system, antenna feeder and lightning receiving device, and signal line. Therefore, any damage caused by lightning primarily comes from the voltage difference between the equipment in the eNB and one or more of the four interfaces. The pole grounding is shown in Figure 3-9.

Figure 3-9: Pole Grounding

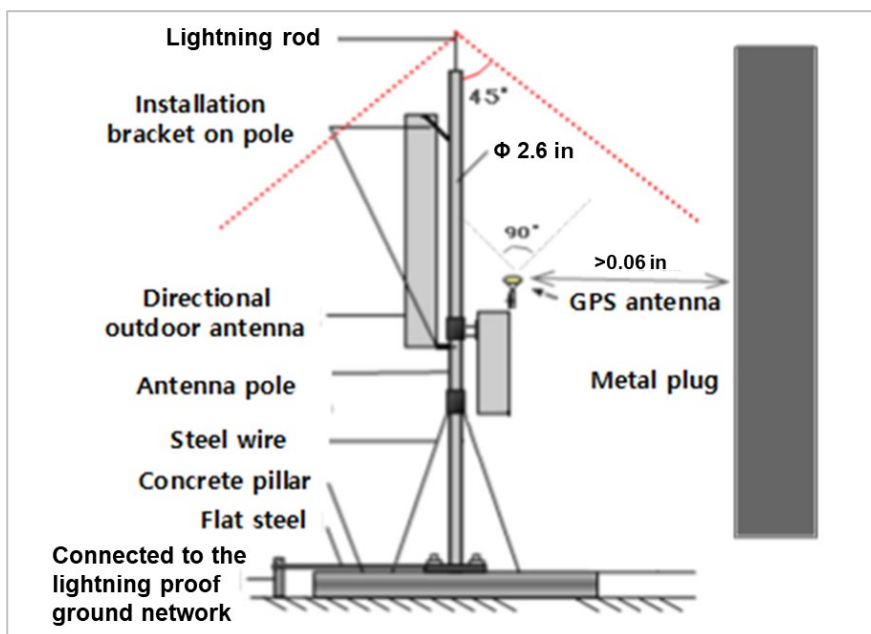

1. The installation position of the grounding bar should meet the design requirements. The holding pole and tower body must be connected to the lightning protection network, or grounded with a separate lead.
2. The diameter of the grounding wire should meet the design requirements. The copper nose must be used for grounding, and the grounding resistance is required to be less than 10 ohms. If the resistance of the public network communication equipment placed in other systems is less than 10 ohms, the grounding network of the system should be overlapped.
3. The grounding wire must be the whole wire material. When laying, it should be bound separately with other cables. All grounding wires should be fixed with wire core or binding tape with a fixed spacing of 0.3 m.
4. The copper bar must be used for the grounding bar, and the specification of the grounding bar shall meet the design requirements. If there are no specific requirements in the design, 300 × 40 × 4 mm and fixed with expansion bolts.

5. The grounding wire must be made of the whole cable material, the intermediate joint is strictly prohibited, and the excess length should be cut. The skin shall be complete, and the insulation resistance of the core wire to the ground (or metal isolation layer) shall meet the technical requirements of the cable.
6. The grounding wire shall be connected to the integrated grounding bar of the building. If it is impossible to connect to the integrated grounding bar of the building, the appropriate grounding point can be selected according to the integrated grounding situation of the indoor building. The selection of grounding point must be higher than the grounding grid, and the feeder grounding shall be towards the downward direction of the feeder, never upward.
7. The grounding electrode of the self-built grounding grid for the outdoor antenna of the tunnel must meet the design requirements. The buried depth of the grounding electrode and the welding quality of the flat iron meet the specification requirements. In principle, the buried depth of the grounding electrode shall not be less than 0.7 m. The non-self-built grounding network shall be connected to the grounding network of the owner.
8. The eNB grounding, power adapter grounding, distribution box grounding and feeder grounding must be connected to the grounding bar independently, and the grounding bar must have a path from the lead to the earth.

3.5 Maintenance Chamber Waterproofing

Once the installation is complete, you must close the maintenance chamber of the equipment and waterproof the chamber.

Put the Ethernet cable on the wire, and seal the wire diameter 7 mm \pm 1 mm.

3.6 Power on to Check LED Status

After the Nova430i is powered on, check that the LED indicators are lighting as expected: Power is steady green, cell activated is slow flash green, and there are no alarms (Figure 3-10) per previous Table 2-3.

Figure 3-10: Check LEDs

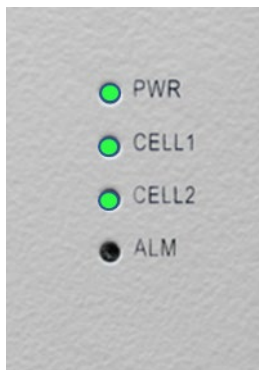

3.7 Configure Basic Parameters

Reference: *eNodeB Configuration Guide*

The Nova430i eNB can be configured in Single Carrier (SC), Carrier Aggregation (CA), or Dual Carrier (DC)/split mode, depending on which licenses you have purchased, and/or in HaloB mode, which is embedded in the base software. The Nova430i also supports CBRS SAS operation.

When first installing and testing the Nova430i, Baicells recommends configuring the primary cell (Pcell)/Cell 1 carrier settings (without enabling CA, DC, HaloB, or SAS) for simple verification that the new eNB unit is operational. Once it is confirmed to be operational, you can then refer to the appropriate configuration guide(s) for the operating mode you plan to use.

NOTE: For all GUI menus and fields, refer to the following documents on the Baicells website: Baicells.com > Resources > *Documents*.

- CloudCore Configuration & Network Administration Guide (OMC/BOSS)
 - CPE Configuration Guide
 - eNodeB Configuration Guide
 - Carrier Aggregation & Dual Carrier (Split Mode) Configuration Guide
 - HaloB User Guide
 - SAS Deployment Guide
-

3.7.1 Launch the eNB GUI

Follow the steps below to connect to the Nova430i GUI.

- Step 1: Use an Ethernet cable to connect the eNB WAN/PoE+ port to the local network routed to the Internet. The DATA interface is set to DHCP client by default.

Optionally, you can plug a PC directly into the eNB MGMT port. On your PC you will need to assign a static IP address within the MGMT subnet. The default IP address for the MGMT interface is <http://192.168.150.1/24>.

- Step 2: Open a Web browser, and enter the following IP address: <http://192.168.150.1>.
- Step 3: At the login screen (Figure 3-11), enter the default user name (*admin*) and password (*admin*) and click on *Login* to open the home page.

Figure 3-11: GUI Login

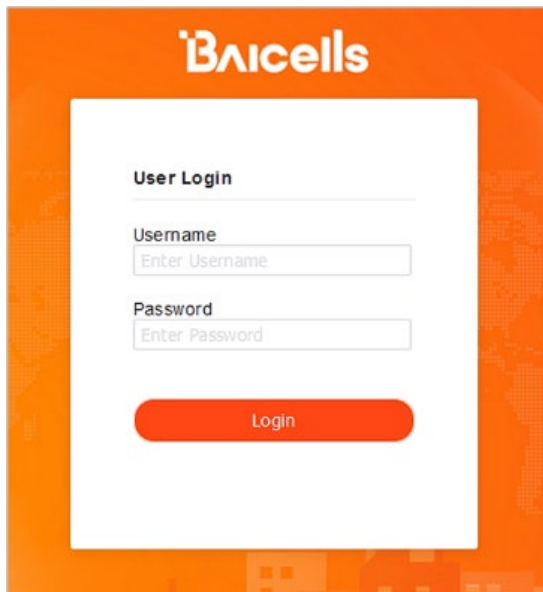

The home page is the *Basic Setting* > *Basic Info* menu, which reports the current eNB status (Figure 3-12). In [section 3.5.7](#), you will use this page to confirm that the eNB is active.

Figure 3-12: Home Page

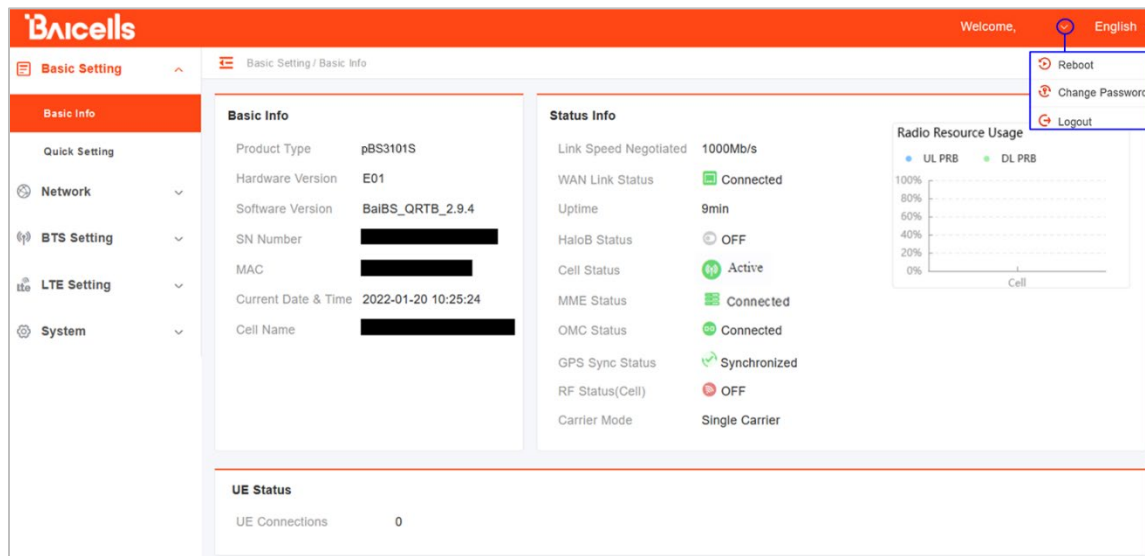

Optionally, you may want to:

1. Change the login password.
2. Confirm the firmware version is the latest available from Baicells; upgrade if needed. Firmware upgrades can be found at Baicells.com > Support > [Firmware](#). See [Section 3.7.2](#)

for detailed instructions regarding firmware upgrades.

3. Set the Network Timing Protocol (NTP).

For help, refer to the [CloudCore Configuration & Network Administration Guide](#).

3.7.2 Upgrade Firmware

To ensure you are using the most recent software version before configuring the eNB, follow the steps below.

3.7.2.1 Upgrade Firmware from the eNB GUI

1. Download the most recent firmware file from Baicells.com > Support > [Firmware](#), and save on local computer.
2. Go to *System > Upgrade*, and select whether to preserve the current settings.
3. Select *Choose File*, and navigate to the firmware file saved on local computer.

NOTE: The file type is *.IMG

4. Click *Upgrade*.
5. In the pop-up window click *PROCEED*.
6. The base station reboots after approximately three minutes.
7. On the *Basic Setting > Basic Info* page, the upgraded version is displayed in *Software Version*.

3.7.2.2 Upgrade Firmware from the OMC

1. Go to *eNB > Upgrade > Upgrade&Rollback*.
2. Select the correct *Product Type* from the list.
3. Select the checkbox next to the eNB(s) you want to upgrade.
4. In the *New Task* window, select the *Upgrade Type*.
5. In the eNB section, select the checkbox(es) next to the eNB(s) you want to upgrade.
6. Next to *File List*, select/deselect *Retain Configuration*. Under *Select*, choose the software version by clicking in the empty cell (a blue checkmark will appear).
7. Choose the *Execute Type*, which determines when the upgrade will occur.
8. Select *OK*.

3.7.3 Basic Configuration Overview

Figure 3-13 indicates four main steps for basic configuration: network interfaces, management server address, quick settings pertaining to key LTE parameters, and the carrier setting.

Figure 3-13: Configuration Flow

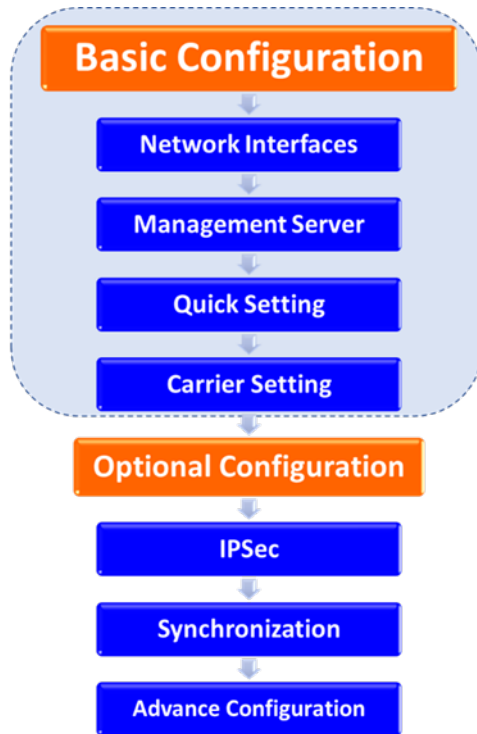

3.7.4 Configure Network Interfaces

The network interfaces defined as part of the initial, basic setup include the WAN/LAN/VLAN interfaces, Dynamic Host Configuration Protocol (DHCP), and the Local Gateway (LGW) mode.

3.7.4.1 WAN/LAN/VLAN

Go to the *Network > WAN/LAN/VLAN* menu (Figure 3-14). The WAN interface is an external communication portal (Internet connection) between the eNB's Network Management System (NMS) – in most cases, the CloudCore OMC – and the Mobility Management Entity (MME). If not using CloudCore, the eNB's NMS may be a Local OMC or the LTE NMS. The *WAN/LAN/VLAN* fields are described in Table 3-1.

If the *IP Access Mode* field is set to *DHCP* and the *LGW* function is *ON* (section 3.5.3.2), the *Connect Type* field must be modified. The IP address of the eNB will be changed due to the MAC address being changed. Therefore, modify the router server at the same time.

The *LAN Config* interface is used only as a local maintenance port during initial eNB setup and basic configuration; it is not used during normal eNB operation. Enter the IP address and subnet mask address for the local network connection. The default IP address for the LAN interface is 192.168.150.1.

NOTE: If the LAN IP address is changed, the eNB will reboot, and you will have to log in to the GUI again.

Figure 3-14: WAN/LAN/VLAN

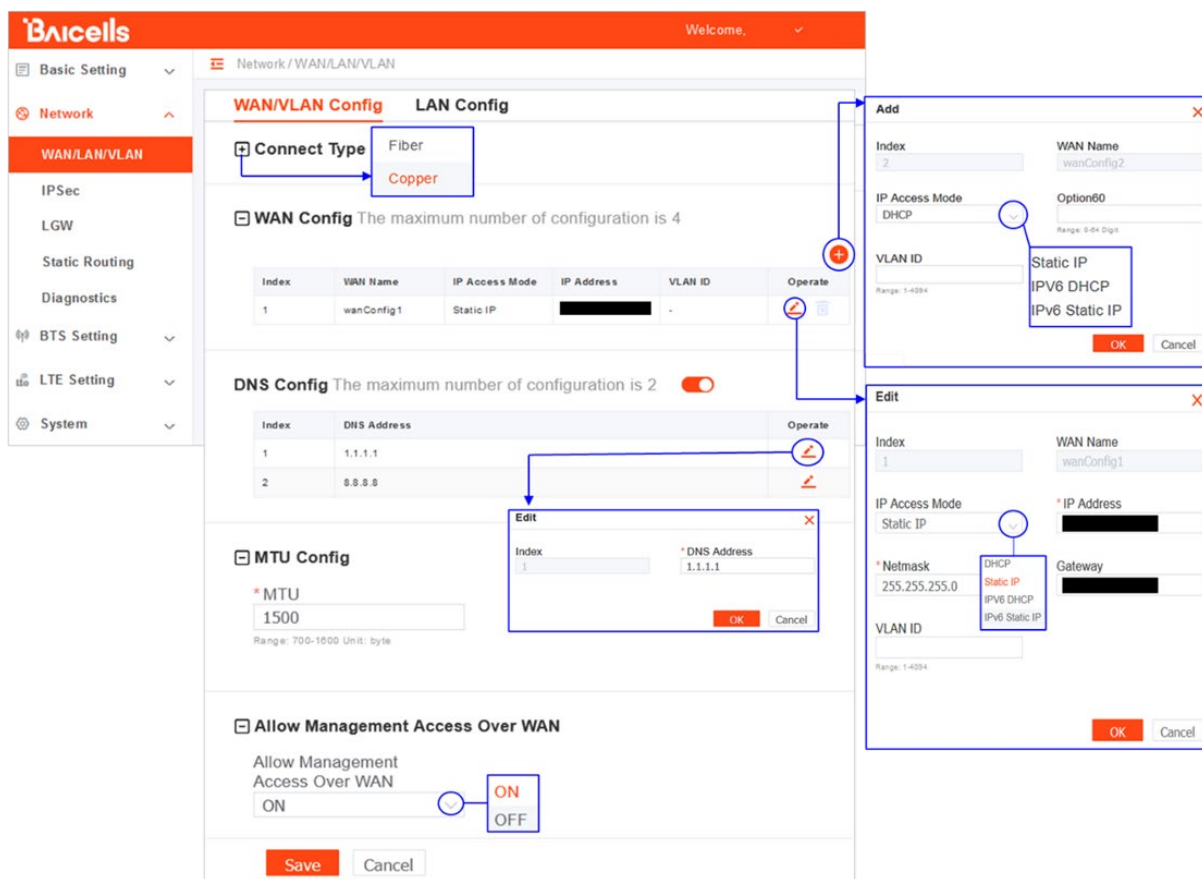

Table 3-1: WAN/LAN/VLAN

Field Name	Description
Allow Management Access Over WAN	Enable or disable the Local Maintenance Terminal connection through the WAN port.
Connect Type	Used to select the type of connection for the eNB (Copper or Fiber)

Field Name	Description
MTU	Used to specify the maximum size of the network layer protocol data unit that can be communicated in a single network transaction. Range is 700 to 1600.
DNS Address 1	Used to define the DNS 1 IP address
DNS Address 2	Used to define the DNS 2 IP address
WAN Config	Used to enable the interface. Four IP addresses are the maximum number the eNB supports.
IP Access Mode	Used to select the desired interface protocol: DHCP, Static IP, IPv6 DHCP, or IPv6 Static IP
Current IP	The WAN interface IP address
Option60	Used to differentiate between different terminal when <i>IP Access Mode</i> is set to <i>DHCP</i>
Subnet Mask	Used to define subnet mask address if <i>IP Access Mode</i> is set to <i>Static IP</i>
Prefix	Prefix of IPv6 address for WAN interface if <i>IP Access Mode</i> is set to <i>IPv6 Static IP</i>
Gateway	Used to define gateway address if <i>IP Access Mode</i> is set to <i>Static IP</i>
VLAN ID	Used to configure more IP addresses for the <i>WAN</i> interface through the VLAN when there is a need to transmit multi-types of data.

3.7.4.2 LGW

The Local GateWay (LGW) setting must be configured when using the Baicells CloudCore Evolved Packet Core (EPC). Refer to Figure 3-15 and Table 3-2. You must reboot the eNB when you make changes to these settings.

Figure 3-15: LGW

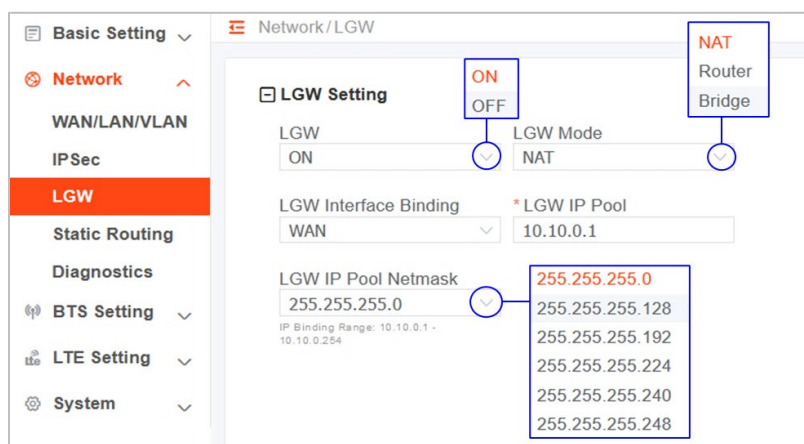

Table 3-2: LGW

Field Name	Description
LGW	On or Off

Field Name	Description
LGW Mode	Select an option: NAT: Packages from the internal network to the external network need Network Address Translation Router: Select optimized route from the routing table (Figure 3-16) Bridge: Transfer in the data link layer
LGW Interface Binding	The IP address connects to the LGW. Select from configured interfaces. Default is WAN interface. The VLAN interface can also be used to separate different links.
LGW IP Pool	Enter the starting IP address of the dynamic IP address pool
LGW IP Pool Netmask	For example, if the first IP address is 10.10.10.1 and the netmask is 255.255.255.0, the IP address pool includes 255 IP addresses. The options are shown in the pull-down menu: 
Static Address	If <i>LGW Mode = Router</i> (Figure 3-16), set to <i>ON</i> if you want to use a static IP address.
First Address	If <i>LGW Mode = Router</i> and <i>Static Address = ON</i> (Figure 3-16), enter the first static IP address in the range.
Last Address	If <i>LGW Mode = Router</i> and <i>Static Address = ON</i> (Figure 3-16), enter the last static IP address in the range.
IMSI to IP Binding - IMSI	If <i>LGW Mode = Router</i> and <i>Static Address = ON</i> (Figure 3-16), if you want to bind an IMSI number to the IP address, enter the IMSI number.
IMSI to IP Binding - IP	If <i>LGW Mode = Router</i> and <i>Static Address = ON</i> (Figure 3-16), enter the IP address to bind to the IMSI. You can add more than one IP address.

Figure 3-16: LGW = Router



3.7.4.3 Static Routing

When using static routing, go to *Network > Static Routing*. The *Network > Static Routing* landing page has two main sections, *Static Routing Config* and *Validated Route List* (Figure 3-17). The configured static route information are displayed under *Static Routing Config*. To edit a static route in the list, click on the **edit** icon, enter the information, and click *OK*. To add a static route, click the **Add** icon. Fill in the information and click *OK*. Field descriptions are in Table 3-3.

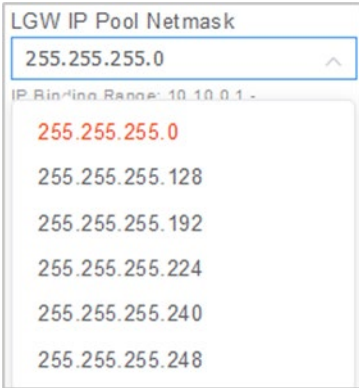
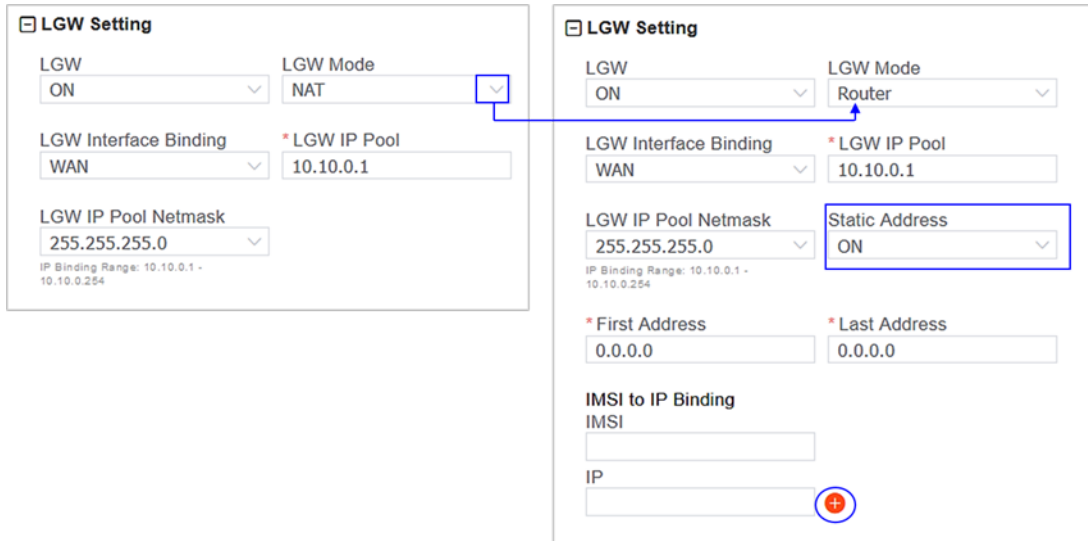
Figure 3-17: Static Routing

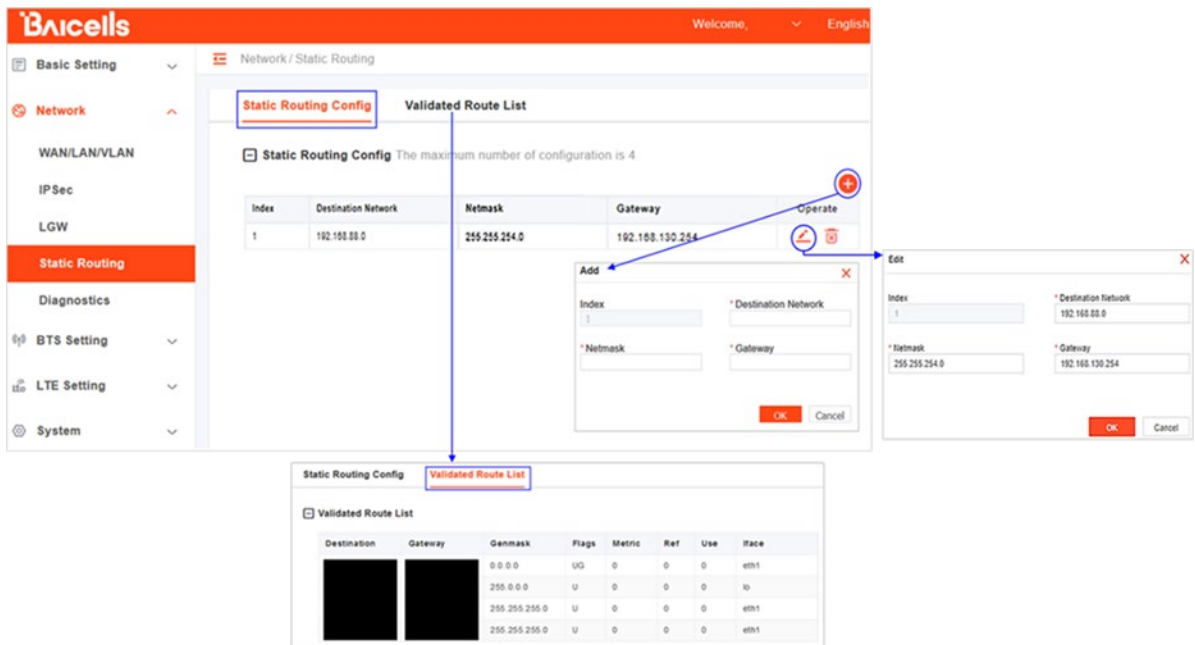

Table 3-3: Static Routing

Field Name	Description
Index	Auto-generated router index number
Enable	Enable/Disable the static route
Destination Network	The destination IP address
Netmask	The destination subnet mask
Gateway	The destination gateway IP address

3.7.5 Configure the Management Server

In the *BTS Setting > Management Server* window, you will enter the network management service (NMS) information (Figure 3-18). When using the Baicells CloudCore to manage the network, in the *http://* field, enter the following URL address and port number:

baiomc.cloudapp.net:48080/smallcell/AcsService

If you are using Local OMC or another NMS, enter its server address and port number. Refer to the field descriptions in Table 3-4.

Figure 3-18: Management Server

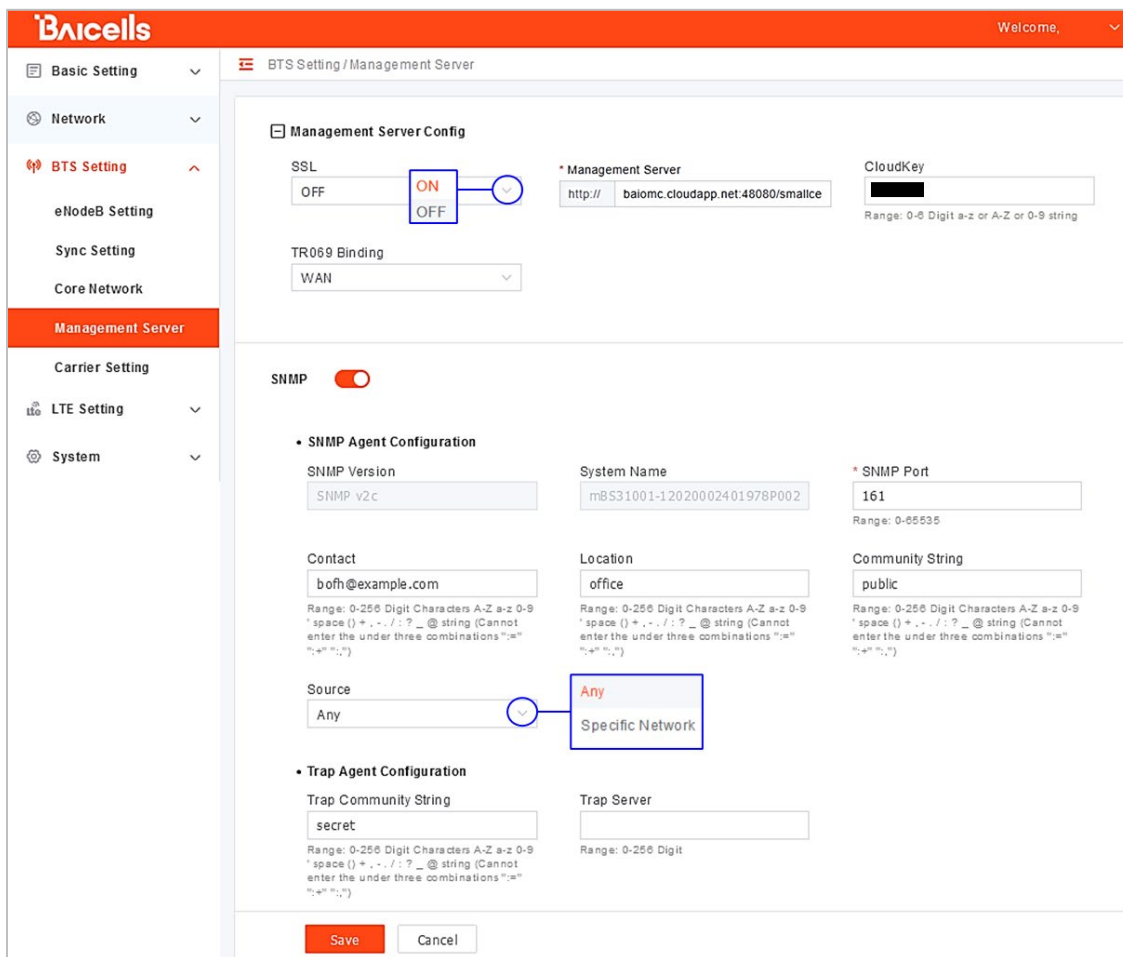



Table 3-4: Management Server

Field Name	Description
SSL	Enable/Disable Secure Socket Layer (SSL) using <i>ON/OFF</i> . When enabled the Management Server field changes to a secure http extension.
Management Server	Enter the management server IP address and port number
CloudKey	Operators using the Baicells CloudCore are provided a unique CloudKey identifier that may be used when configuring CPEs and eNBs. If entered in this field, when the device is powered on it will immediately associate to the operator's OMC account. You can find your CloudKey ID when you log in to the CloudCore. It is displayed in the top bar.
TR069 Binding	Binds TR-069 protocol information to a specific server.
SNMP	Enabled= OFF/ON

Field Name	Description
	
SNMP Agent Configuration	Option available when SNMP option is enabled: <ul style="list-style-type: none"> • SNMP Version • SNMP System Name • SNMP Port • Contact • Location • Community String • Source
Trap Agent Configuration	Option available when SNMP option is enabled: <ul style="list-style-type: none"> • Trap Community String • Trap Server

3.7.6 Configure Quick Settings

Under the *Basic Setting > Quick Setting* window (Figure 3-19) are several important fields you must configure and/or verify. First, if the operator is using the Baicells CloudCore EPC, you must enter a fixed Public Land Mobile Network (PLMN) and MME IP address:

- PLMN = **314030**
- MME IP = **10.3.0.9 and 10.5.0.9**

Do not change these settings except when connecting to a Local (private network) EPC or different vendor's Evolved Packet Core (EPC). Second, you must enter the operator's planned settings for Band, Bandwidth, EARFCN, Cell ID, PCI, TAC, etc. Some *Quick Setting* fields such as *Duplex Mode* and *Frequency* will auto-fill based on the eNB hardware model. Make sure the *Cloud EPC* field is set to *ON* when using the Baicells CloudCore. If you are testing the eNB in a lab environment, turn the power down as low as it will go under the *Power Modify* field.

NOTE 1: If planning to use CBRS SAS, the SAS vendor will determine some of these parameters. Refer to the [SAS Deployment Guide](#) for more information.

NOTE 2: Nova430i does not support SFA = 0.

For a description of all the eNB *Quick Setting* fields, refer to the [eNodeB Configuration Guide](#).

Figure 3-19: Quick Setting

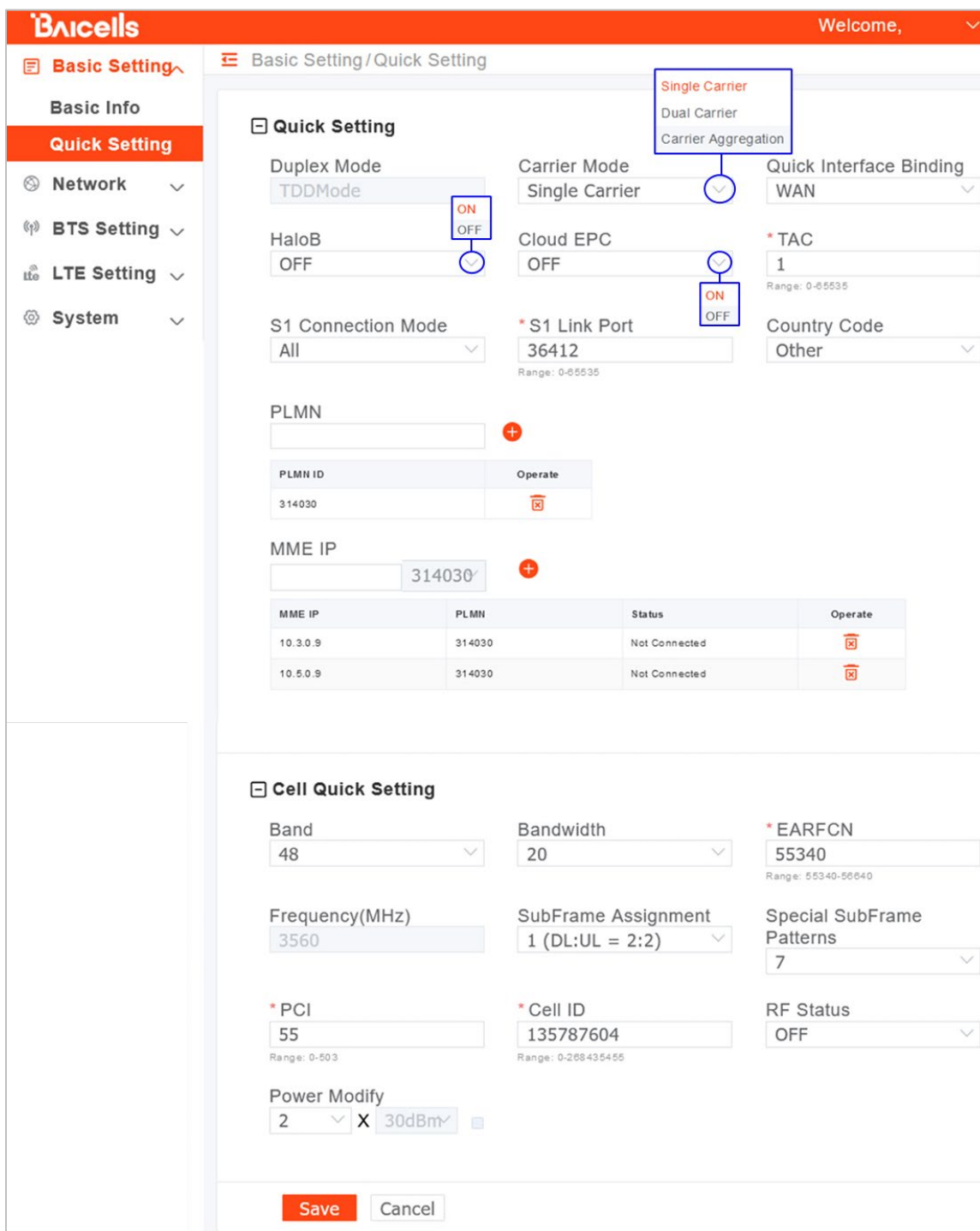

3.7.7 Configure Carrier Setting

Reference: *Carrier Aggregation & Dual Carrier (Split Mode) Configuration Guide*

The *Carrier Setting* menu is used only in the two-carrier Nova430i eNB (Figure 3-20). You can set the eNB to run as a single carrier, as two combined carriers using Carrier Aggregation (CA), or as two independent carriers using Dual Carrier (DC)/split mode, depending on which licenses you

have purchased. Single carrier (no CA) means only Cell 1 will operate and use only two RF ports instead of four. Operators may need to use this mode if they have limited spectrum or are planning to change to CA or DC mode at a later time when more capacity is needed for the coverage area. Go to *BTS Setting > Carrier Setting* to configure *Carrier Mode*. Click the arrow to view the drop-down menu.

Whenever you change the carrier setting, you must **reboot** the eNB for the change to take effect.

Figure 3-20: Carrier Setting

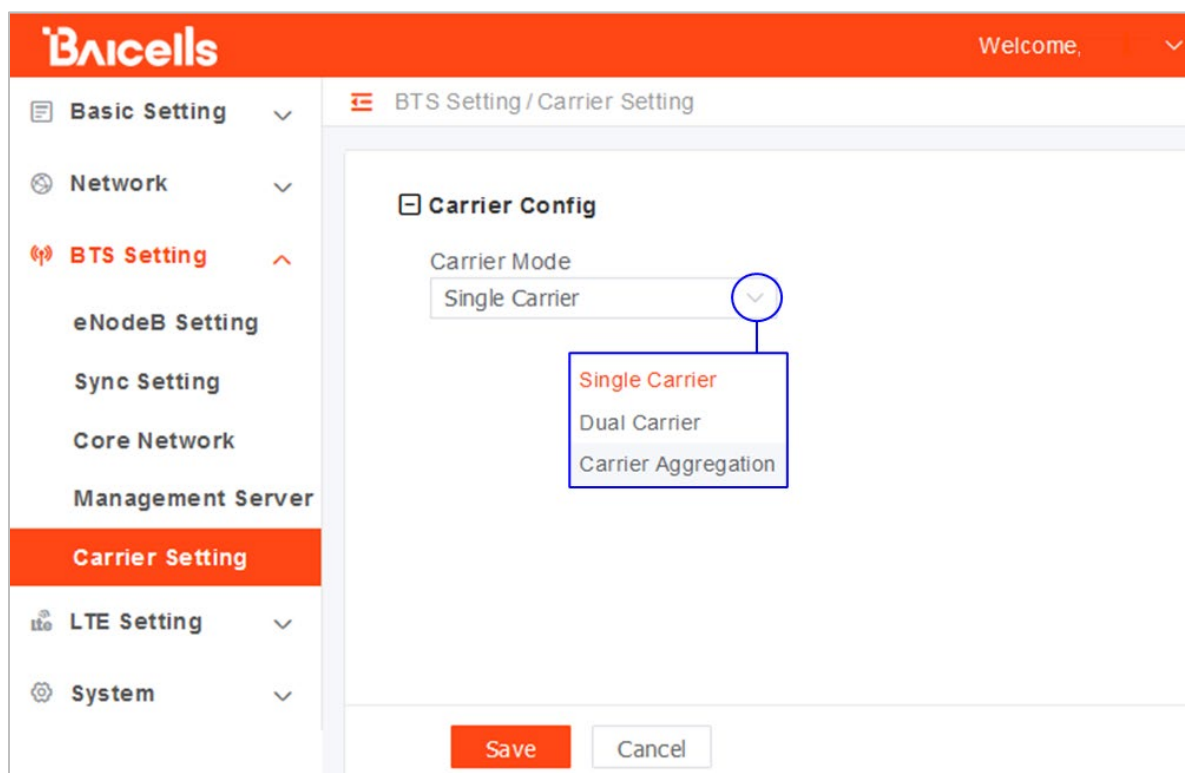

3.7.8 Reboot

Once the basic configuration settings are saved, reboot the eNB. There are two options for rebooting in the eNB GUI. From the landing page of the eNB GUI, navigate to *System > Reboot*, or select *Reboot* under the *Welcome* banner (Figure 3-21).

Figure 3-21: Reboot

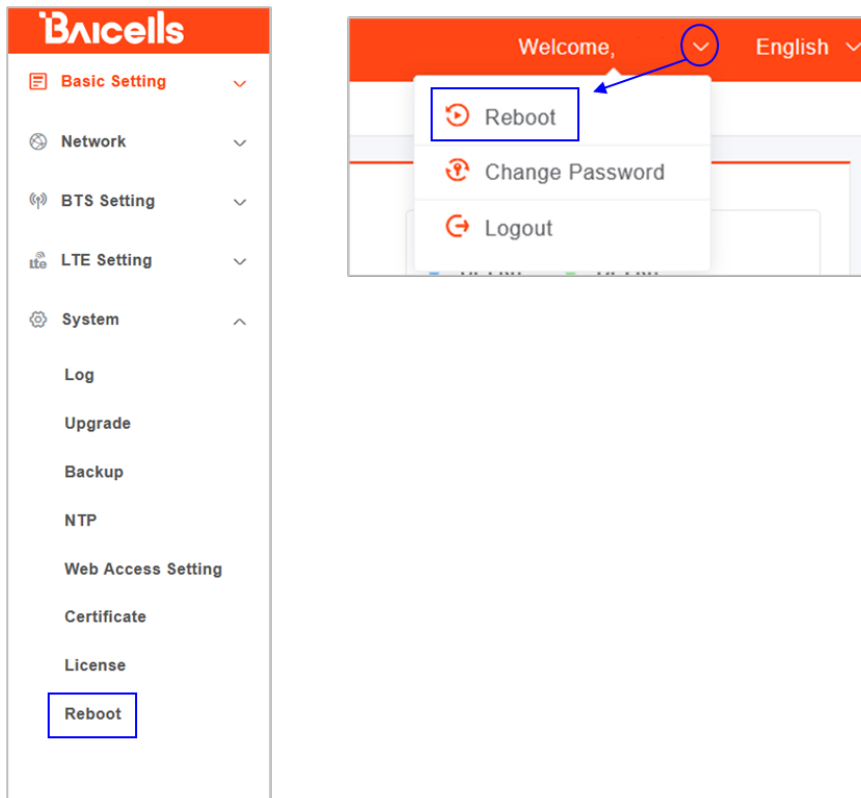

3.7.9 Verify eNB Operational Status

When the eNB is finished rebooting, check the eNB status using the eNB GUI and the OMC. Once the eNB is mounted at its intended destination and powered on, recheck the status settings.

- **eNB GUI:** Go to *Basic Setting > Basic Info* and check the *Cell Status* field (Figure 3-22). It should show *Active*. Also, check that *GPS Sync* is reported as *Synchronized*.
- **OMC:** Go to *eNB > Monitor* to see if the *Cell Status* shows *Active* and the *Sync Status* shows *GPS Synchronized* (Figure 3-23).

NOTE: Ensure you have selected ALL in the display settings window in the OMC > eNB > Monitor page to view *Cell Status* and *Sync Status* (Figure 3-24).

Figure 3-22: Cell Status (eNB GUI)

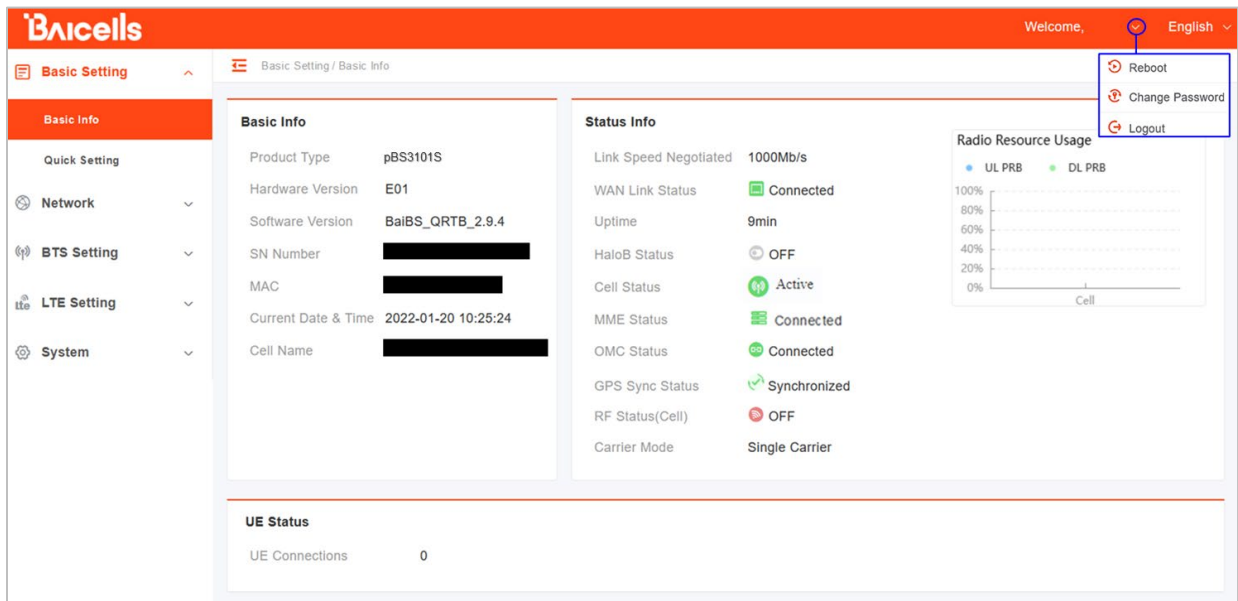

Figure 3-23: Cell Status (OMC)

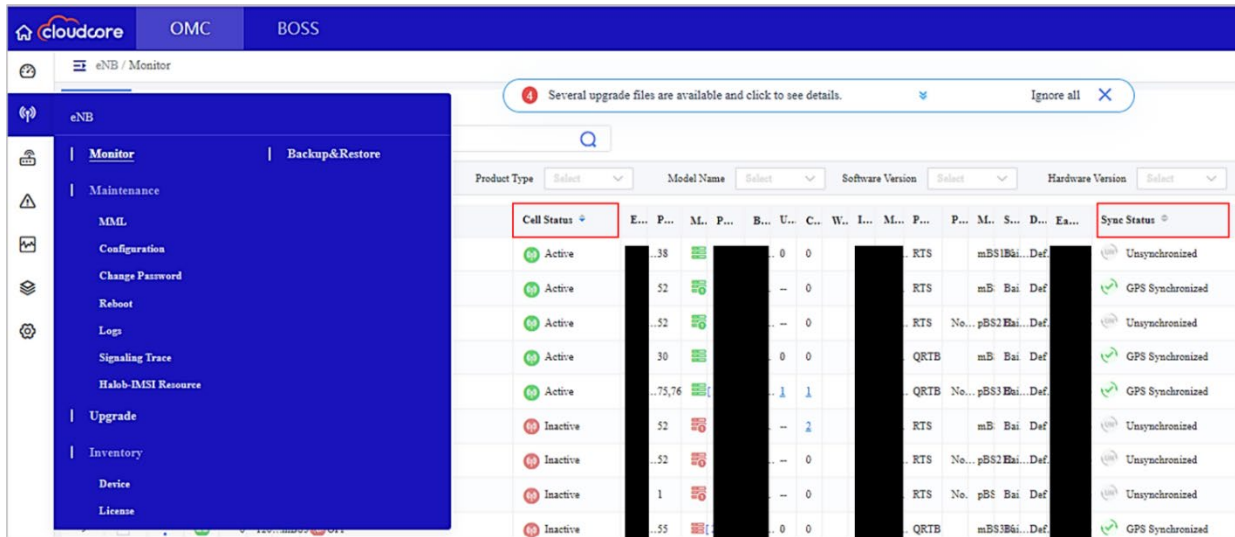
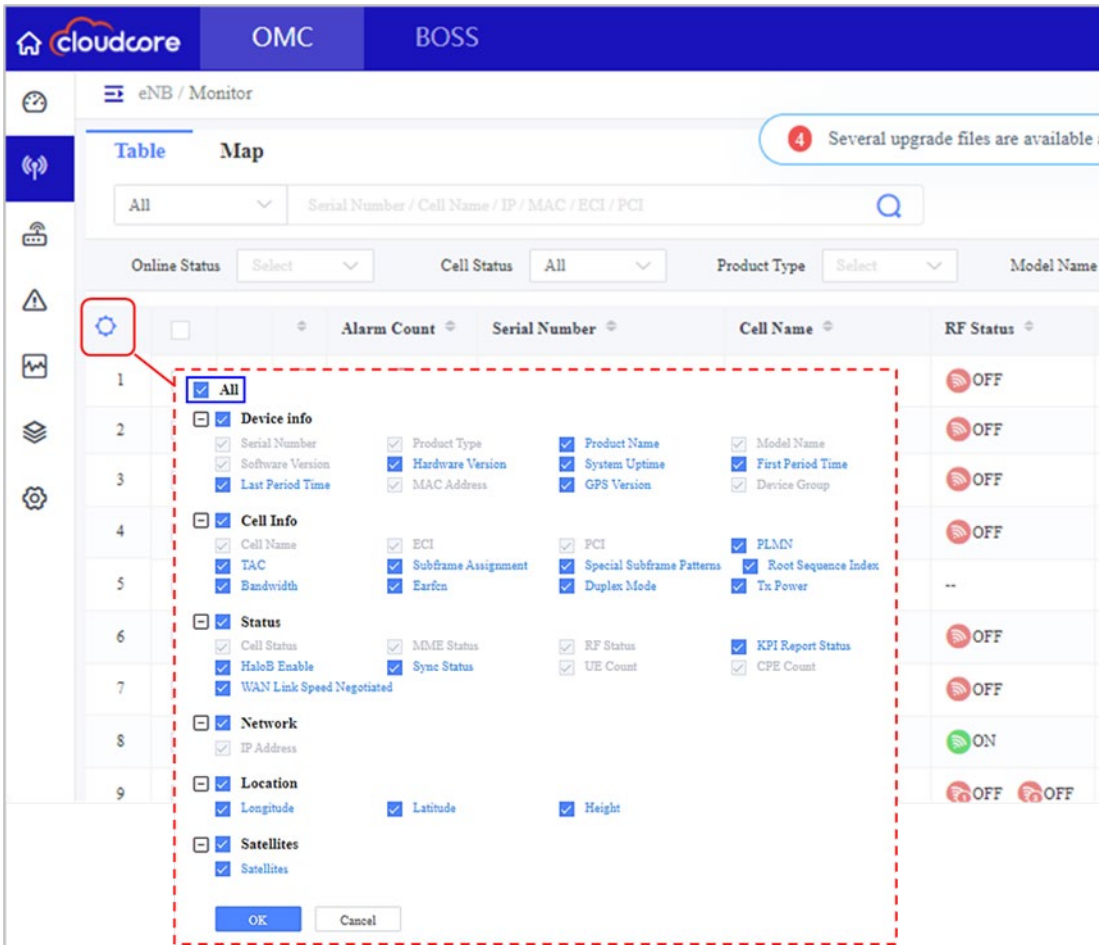

Figure 3-24: OMC > eNB > Monitor > Display Settings



Before commercial operation, Baicells recommends implementing cell site acceptance testing of a new site to ensure the service meets expectations, to document network speeds at various locations in the cell, and to verify RF coverage.

Appendix: Regulatory Compliance

FCC Compliance

This device complies with part 15 of the FCC Rules. Operation is subject to the following two conditions: (1) This device may not cause harmful interference, and (2) this device must accept any interference received, including interference that may cause undesired operation. Any Changes or modifications not expressly approved by the party responsible for compliance could void the user's authority to operate the equipment.

This equipment has been tested and found to comply with the limits for a Class B digital device, pursuant to part 15 of the FCC Rules. These limits are designed to provide reasonable protection against harmful interference in a residential installation. This equipment generates, uses, and can radiate radio frequency energy and, if not installed and used in accordance with the instructions, may cause harmful interference to radio communications. Operation of this equipment in a residential area is likely to cause harmful interference, in which case the user will be required to correct the interference at his own expense.



WARNING: This equipment complies with FCC radiation exposure limits set forth for an uncontrolled environment. This equipment should be installed and operated with a minimum distance of 20 inches (50 cm) between the radiator and your body.

ISED Compliance

This device complies with Innovation, Science, and Economic Development Canada license-exempt RSS standard(s).

Operation is subject to the following two conditions: (1) This device may not cause interference, and (2) This device must accept any interference, including interference that may cause undesired operation of the device.

The antenna(s) used for this transmitter must be installed to provide a separation distance of at least 20 inches (50 cm) from all persons and must not be collocated or operating in conjunction with any other antenna or transmitter, End-Users must be provided with transmitter operation conditions for satisfying RF exposure compliance.